

interierskin
THE WORLD OF GLASS

M&T



GLASS

M&T značka kování, která je inovativní ve všech produktových řadách dveřního a okenního kování.

Jsme jediný výrobce kování v Evropě, který na trh dodává kování na sklo a řadu dalších doplňků na skleněné dveře nadstandardně také v několika odstínech titanových povrchů.

Veškeré dveřní kliky z naší produkce je možno kombinovat se všemi typy zámků a pantů na sklo a zároveň zvolit jednotnou povrchovou úpravu včetně titanových povrchů s 15-ti letou zárukou.

Ve stejných barevných odstínech a designových řadách jsou pro Vás připraveny i další důležité doplňky – madla, mušle, posuvné systémy.



Cr lesklý chrom



TiN-C titan chrom mat



SNi matný nikl



TiN-B titan braun mat



SNi-broušeno matný nikl broušený



TiN-K titan černý mat



ENTERO

ENTERO

TiN-K titan černý mat



klika Entero

TiN-K titan černý mat



klika Mimolimit jilm

TiN-C titan chrom mat



klika Sogut

SNi matný nikl cylindrický



klika Mimolimit teak

Cr lesklý chrom WC



klika Terry

SNi-broušeno matný nikl broušený WC



klika Entry

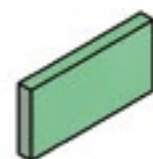
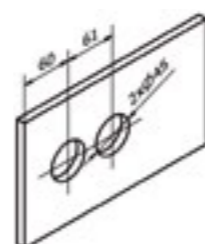
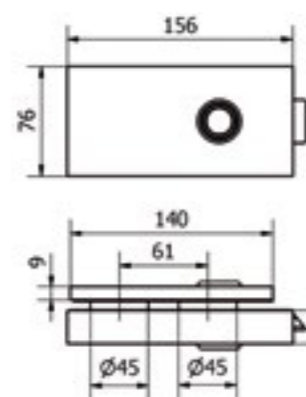
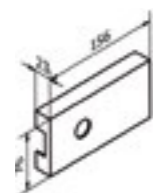

PRO SKLO TL. 8-10-12mm

standard

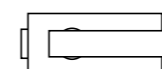

cylindrický

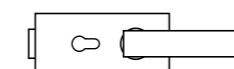

WC

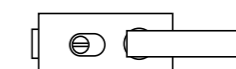

zámek s protikusem

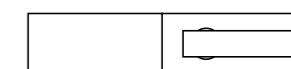

ENTERO

MONTÁŽNÍ NÁVOD ZÁMEK ENTERO

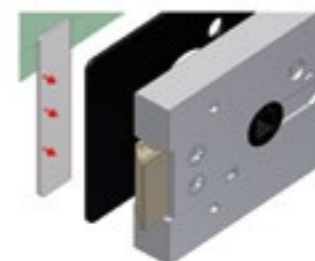
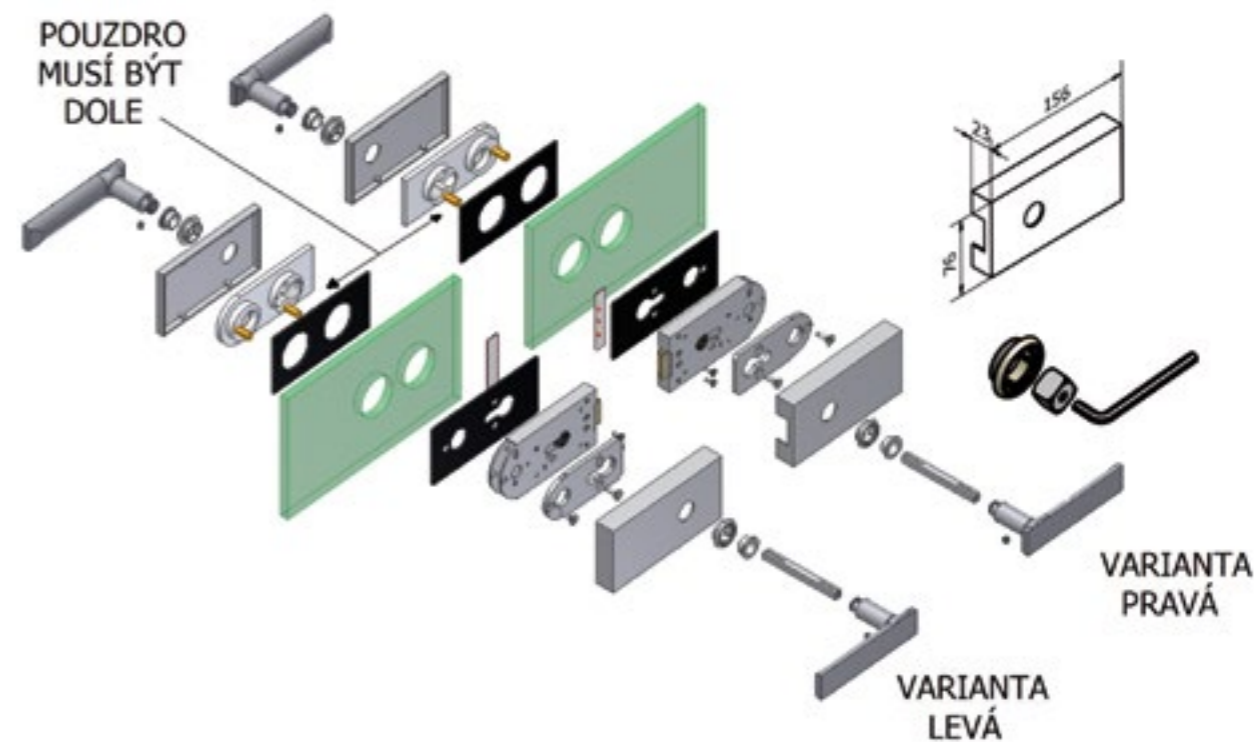

ZÁMEK PRAVO/LEVÝ

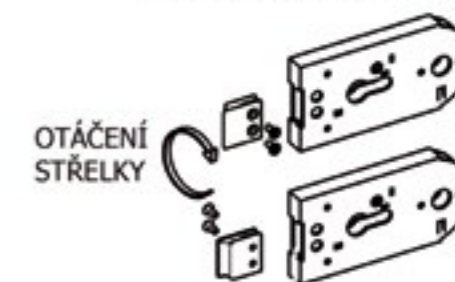

LEPENÍ KRYCÍ PÁSKY NA GUMU U STŘELKY ZÁMKU.
Pozn.: TĚSNÍCÍ GUMA PŘESAHUJE OPROTI DRUHÉ STRANĚ ZÁMKU

zámek ENTERO	TiN-C		TiN-K		TiN-B	
	Kč/EUR	EAN 85950369...	Kč/EUR	EAN 85950369...	Kč/EUR	EAN 85950369...
standard	4980,-/203,-	87835	5180,-/211,-	87798	5380,-/220,-	90774
cyklindrický WC	5020,-/205,-	87842	5220,-/213,-	87804	5420,-/221,-	90781
protikus	5580,-/228,-	87859	5780,-/236,-	87811	5980,-/244,-	90798
	5780,-/236,-	87866	5980,-/244,-	87828	6180,-/252,-	90804

zámek ENTERO	SNI / SNI-broušeno		Cr	
	Kč/EUR	EAN (SNI) 85950369...	Kč/EUR	EAN 85950369...
standard	3980,-/162,-	87750 / 90736	4380,-/179,-	87675
cyklindrický WC	4020,-/164,-	87767 / 90743	4420,-/180,-	87682
protikus	4480,-/183,-	87774 / 90750	4920,-/201,-	87699
	4680,-/191,-	87781 / 90767	5120,-/209,-	87705

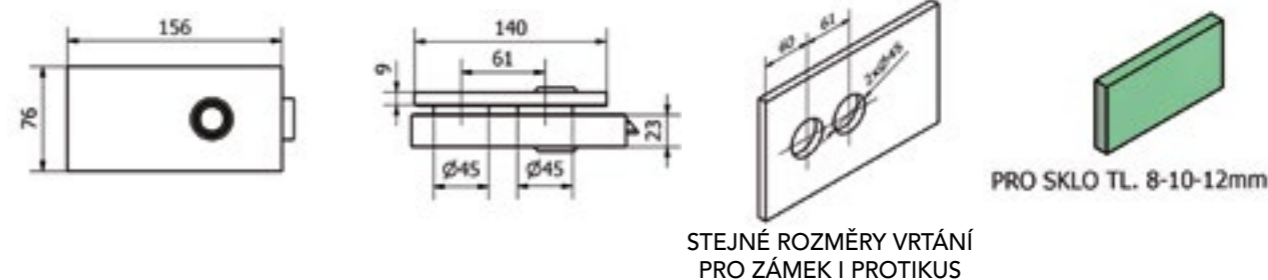

MINI



MINI

Cr lesklý chrom



klika Mini-T

TiN-B titan braun mat



klika Tukan

TiN-K titan černý mat



klika Mimolimit Alu kompakt

SNi matný nikl



klika Mini-C

TiN-C titan chrom mat

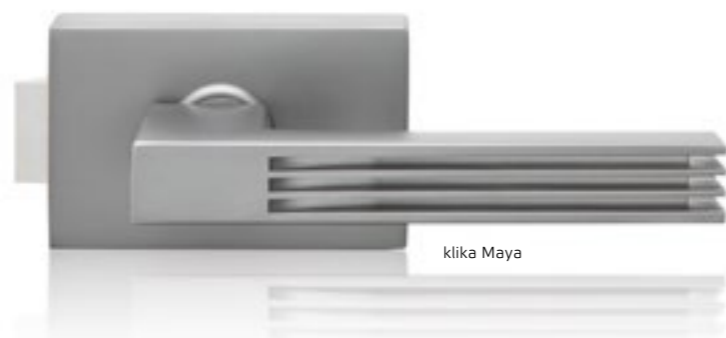

klika Maya

SNi-broušeno matný nikl broušený WC



klika Lara

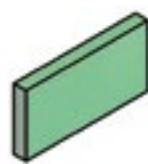
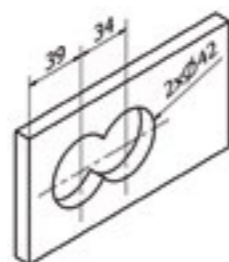
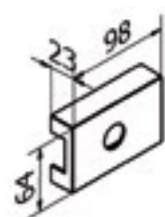

PRO SKLO TL. 8-10-12mm

standard

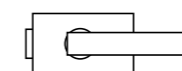

WC

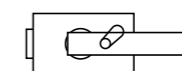

zámek s protikusem

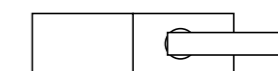

MINI

Cr lesklý chrom



klika Terry

TiN-K titan černý mat



klika Mini-V

SNi-broušeno matný nikl broušený



klika Entero

SNi matný nikl



klika Lusy

SNi-broušeno matný nikl broušený



klika Mimolimit teak

SNi matný nikl



klika Sogut

MINI

MONTÁŽNÍ NÁVOD ZÁMEK MINI

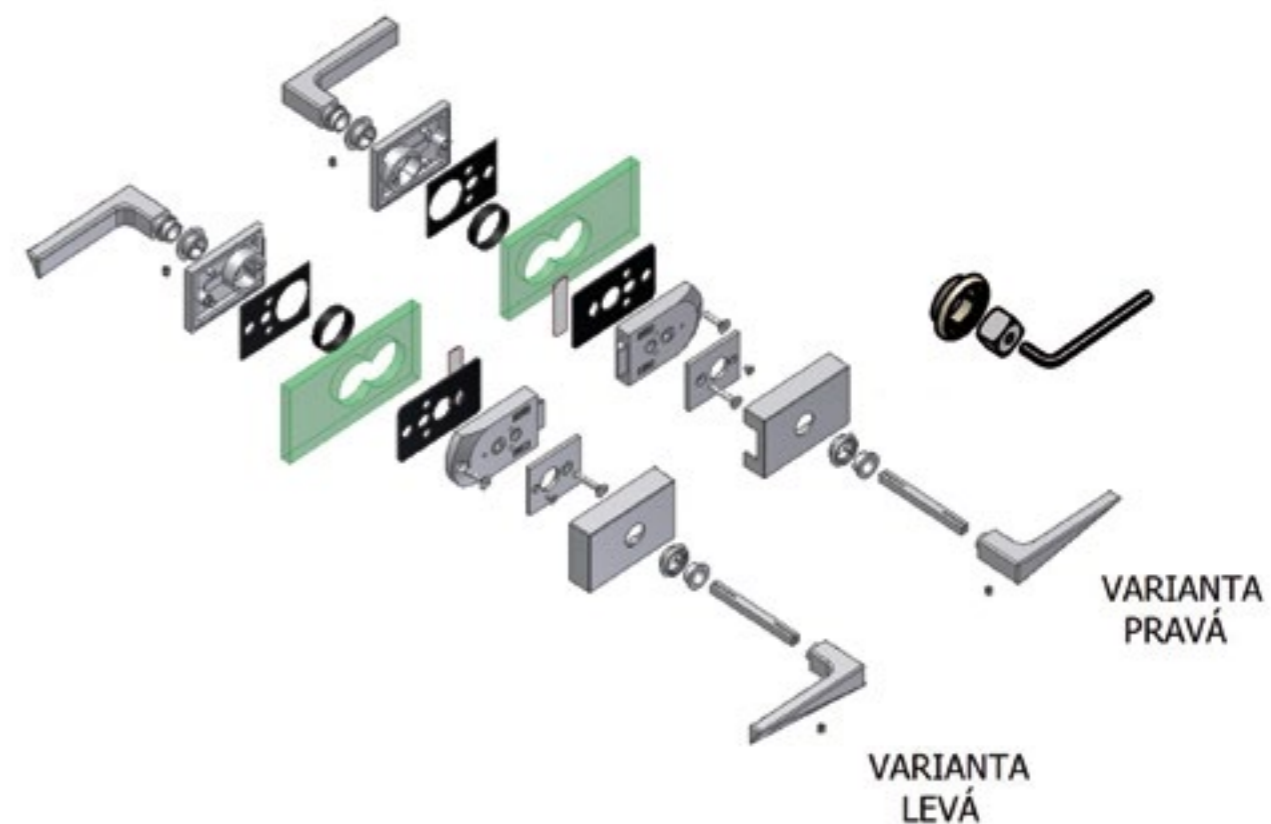

LEPENÍ KRYCÍ PÁSKY NA GUMU U STŘELKY ZÁMKU.
Pozn.: TĚSNÍCÍ GUMA PŘESAHUJE OPROTI DRUHÉ STRANĚ ZÁMKU

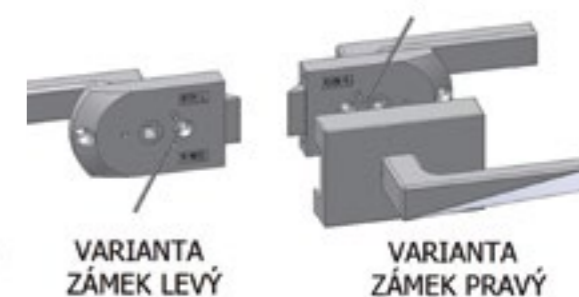

zámek MINI	TiN-C		TiN-K		TiN-B	
	Kč/EUR	EAN 85950369...	Kč/EUR	EAN 85950369...	Kč/EUR	EAN 85950369...
standard	4280,-/175,-	87996	4480,-/183,-	87965	4680,-/191,-	88023
WC	4880,-/199,-	88009	5080,-/207,-	87972	5280,-/216,-	88030
protikus	5080,-/207,-	88016	5280,-/216,-	87989	5480,-/224,-	88047

zámek MINI	SNI / SNI-broušeno		Cr	
	Kč/EUR	EAN 85950369...	Kč/EUR	EAN 85950369...
standard	3280,-/134,-	87934/90811	3580,-/146,-	87873
WC	3780,-/154,-	87941/90828	4080,-/167,-	87880
protikus	3980,-/162,-	87958/90835	4280,-/175,-	87897

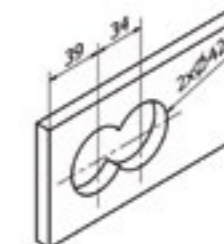
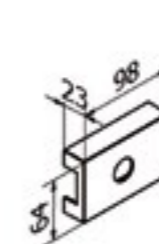

STEJNÉ ROZMĚRY VRTÁNÍ
PRO ZÁMEK I PROTIKUS

TRINITY



TRINITY

Cr lesklý chrom



klika Trinity

TiN-B titan braun mat



klika Toro

SNi-broušeno matný nikl broušený



klika My



klika Toro

SNi-broušeno matný nikl broušený WC



klika Toro

Cr lesklý chrom



klika My

SNi-broušeno matný nikl broušený WC

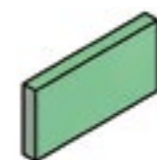
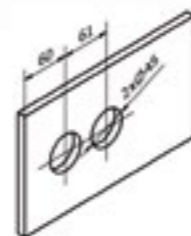
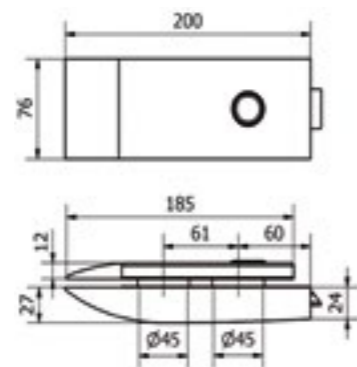
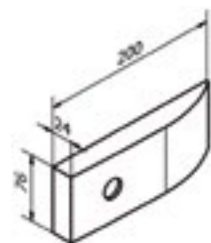

PRO SKLO TL. 8-10-12mm

standard



cylindrický

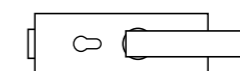

WC

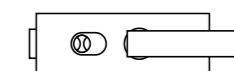

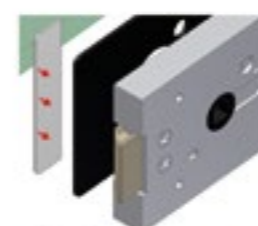
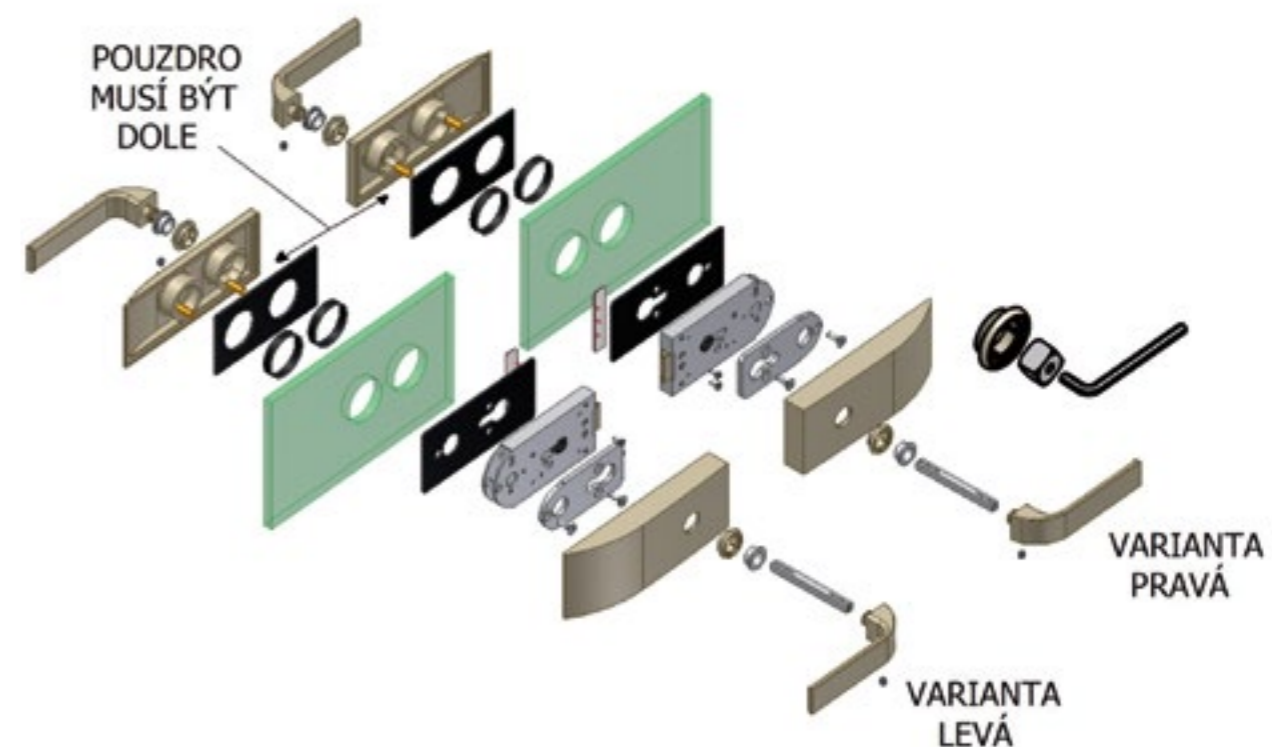

LEPENÍ KRYCÍ PÁSKY NA GUMU U STŘELKY ZÁMKU.
Pozn.: TĚSNÍCÍ GUMA PŘESAHUJE OPROTI DRUHÉ STRANĚ ZÁMKU

ZÁMEK PRAVO/LEVÝ

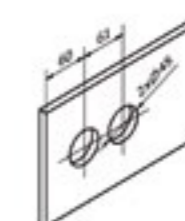
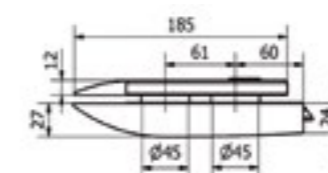
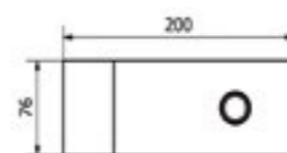
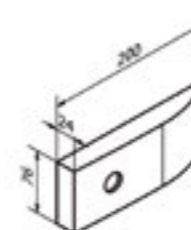
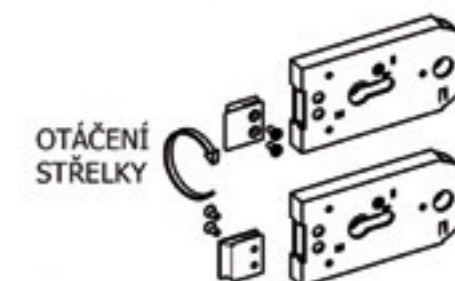

zámek TRINITY	SNI-broušeno		Cr		TiN-B	
	Kč/EUR	EAN 85950369...	Kč/EUR	EAN 85950369...	Kč/EUR	EAN 85950369...
standard	5280,-/216,-	87590	5580,-/228,-	87552	6680,-/273,-	87613
cyklindrický	5320,-/217,-	90217	5620,-/229,-	90200	6720,-/274,-	90224
WC	5780,-/236,-	87606	6080,-/248,-	87569	7280,-/297,-	87620

CHEREZ



CHEREZ

TiN-K titan černý mat



klika Cherez

Cr lesklý chrom



klika Burak

SNi-broušeno matný nikl broušený



klika Cherez

TiN-K titan černý mat



klika Burak

SNi matný nikl



klika Deny

TiN-K titan černý mat



klika Mia

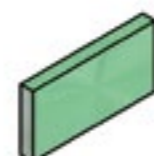
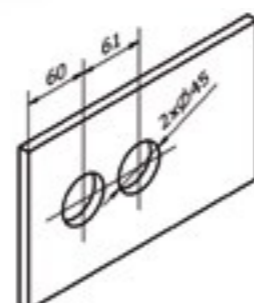
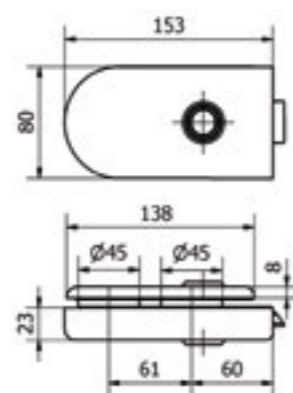
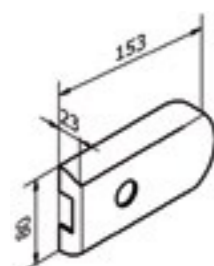

PRO SKLO TL. 8-10-12mm

standard

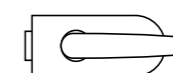

CHEREZ

MONTÁŽNÍ NÁVOD ZÁMEK CHEREZ

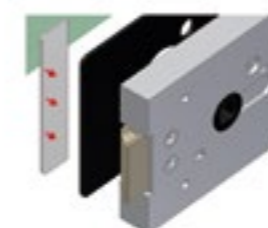
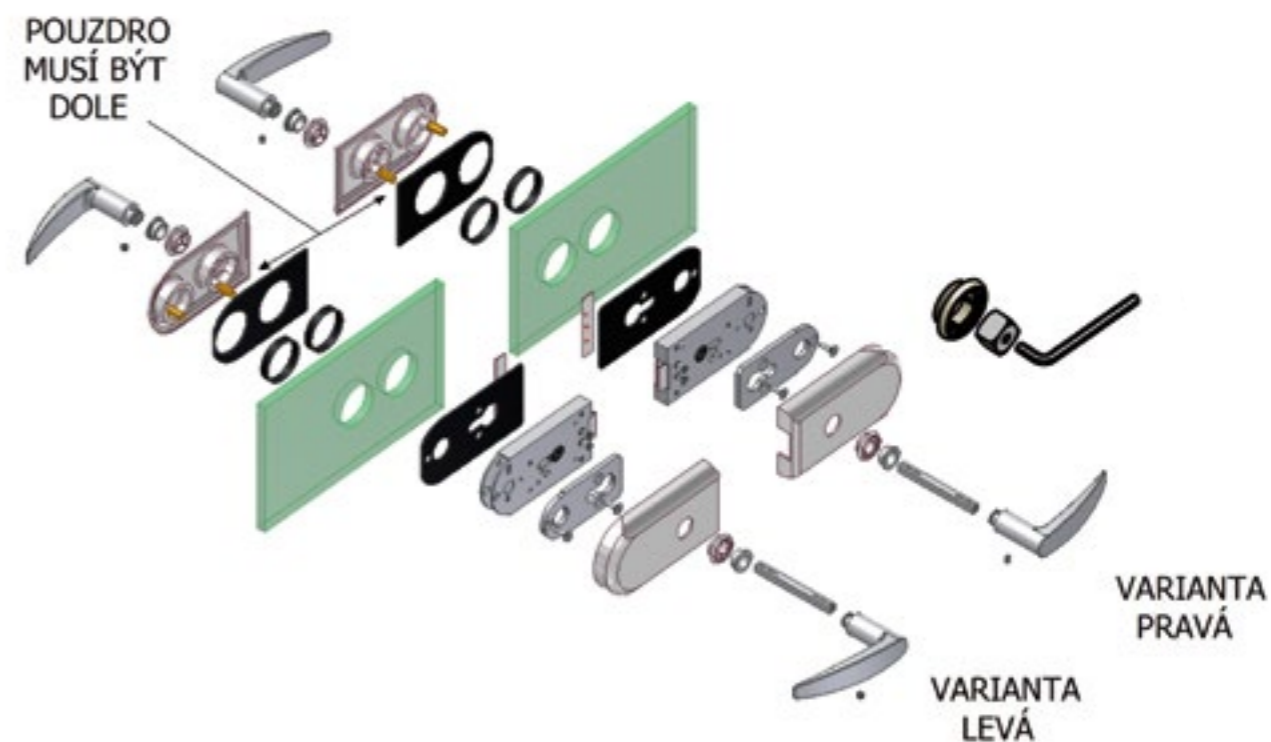

LEPENÍ KRYCÍ PÁSKY NA GUMU U STŘELKY ZÁMKU.
Pozn.: TĚSNÍCÍ GUMA PŘESAHUJE OPROTI DRUHÉ STRANĚ ZÁMKU

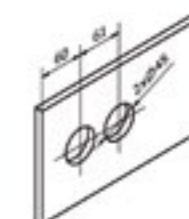
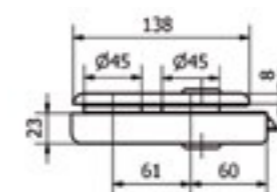
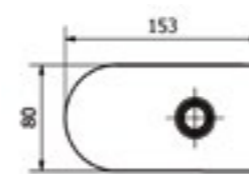
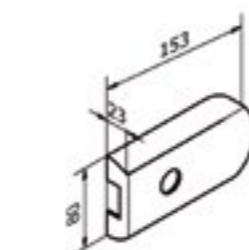

zámek CHEREZ	Sni		Cr		TiN-K	
	Kč/EUR	EAN 85950369...	Kč/EUR	EAN 85950369...	Kč/EUR	EAN 85950369...
standard	3680,-/150,-	87651	4039,-/165,-	87637	4880,-/199,-	87668

TiN-B titan braun mat +3D dub



Cr lesklý chrom + bílá glanz



Jedinečná kolekce s prestižním mezinárodním oceněním



reddot design award
winner 2013



více informací
v kompletním katalogu
Minimal/Maximal

Minimal/Maximal

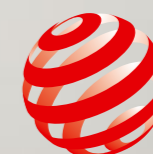

reddot design award
winner 2013

Kliky-rukojeti k zámkům na sklo

Fábi

Povrch	EAN	Kč/EUR
SNi	11007	480,-/20,-
Cr	11014	520,-/21,-
TiN-C	11021	700,-/29,-
TiN-K	11038	800,-/33,-



Burak

povrch	EAN	Kč/EUR
SNi	11243	430,-/18,-
Cr	11250	470,-/19,-
TiN-C	11267	640,-/26,-
TiN-K	11274	750,-/31,-



Garanti

povrch	EAN	Kč/EUR
SNi	11045	510,-/21,-
Cr	11052	550,-/22,-
TiN-C	11069	720,-/29,-
TiN-K	11076	820,-/33,-



Mia

povrch	EAN	Kč/EUR
SNi	11281	430,-/18,-
Cr	11298	470,-/19,-
TiN-C	11304	640,-/26,-
TiN-K	11311	750,-/31,-



Cesan

povrch	EAN	Kč/EUR
SNi	11083	360,-/15,-
Cr	11090	400,-/16,-
TiN-C	11106	565,-/23,-
TiN-K	11113	665,-/27,-



Lusy

povrch	EAN	Kč/EUR
SNi	11328	565,-/23,-
Cr	11335	605,-/25,-
TiN-C	11342	770,-/31,-
TiN-K	11359	875,-/36,-



Andy

povrch	EAN	Kč/EUR
SNi	11120	480,-/20,-
Cr	11137	520,-/21,-
TiN-C	11144	700,-/29,-
TiN-K	11151	800,-/33,-



Deny

povrch	EAN	Kč/EUR
SNi	11373	565,-/23,-
Cr	11380	605,-/25,-
TiN-C	11397	770,-/31,-
TiN-K	11403	875,-/36,-



Kemer

povrch	EAN	Kč/EUR
SNi	11168	535,-/22,-
Cr	11175	575,-/23,-
TiN-C	11182	750,-/31,-
TiN-K	11199	855,-/35,-



Meclis

povrch	EAN	Kč/EUR
SNi	11427	430,-/18,-
Cr	11434	470,-/19,-
TiN-C	11441	640,-/26,-
TiN-K	11458	750,-/31,-



Mondeo

povrch	EAN	Kč/EUR
SNi	11205	720,-/29,-
Cr	11212	760,-/31,-
TiN-C	11229	925,-/38,-
TiN-K	11236	1025,-/42,-



Maty

povrch	EAN	Kč/EUR
SNi	12646	590,-/24,-
Cr	12653	630,-/26,-
TiN-C	12660	800,-/33,-
TiN-K	12677	910,-/37,-



Kliky-rukojeti k zámkům na sklo

Sogut

povrch	EAN	Kč/EUR
SNi	12684	705,-/29,-
Cr	12691	745,-/30,-
TiN-C	12707	910,-/37,-
TiN-K	12714	1010,-/41,-



My

povrch	EAN	Kč/EUR
Cr	12981	1285,-/52,-
SNi-br.	12998	1245,-/51,-
TiN-C	18983	1495,-/61,-
TiN-K	18990	1595,-/65,-



Cherez

povrch	EAN	Kč/EUR
SNi	12752	820,-/33,-
Cr	12769	860,-/35,-
TiN-C	12776	1080,-/44,-
TiN-K	12783	1180,-/48,-



Terry

povrch	EAN	Kč/EUR
Cr	19003	1285,-/52,-
SNi-br.	19010	1245,-/51,-
TiN-C	19027	1495,-/61,-
TiN-K	19034	1595,-/65,-



Entero

povrch	EAN	Kč/EUR
Cr	12806	915,-/37,-
SNi-br.	12813	875,-/36,-
TiN-C	12820	1130,-/46,-
TiN-K	12837	1235,-/50,-
TiN-B	12844	1235,-/50,-



Maya

povrch	EAN	Kč/EUR
SNi-br.	19041	1595,-/65,-
TiN-C	19058	1895,-/77,-
TiN-B	19065	1995,-/81,-



Lara

povrch	EAN	Kč/EUR
Cr	12868	810,-/33,-
SNi-br.	12857	770,-/31,-
TiN-C	12882	1025,-/42,-
TiN-K	12899	1130,-/46,-



Mimolimit

povrch	EAN	Kč/EUR
SNi-br.	19072	1495,-/61,-
TiN-C	19089	1795,-/73,-
TiN-K	19096	1895,-/77,-
TiN-B	19102	1895,-/77,-



Entry

povrch	EAN	Kč/EUR
Cr	12905	1385,-/57,-
SNi-br.	12912	1345,-/55,-
TiN-C	12929	1595,-/65,-
TiN-K	12936	1695,-/69,-



Toro

povrch	EAN	Kč/EUR
SNi-br.	19119	1495,-/61,-
TiN-C	19126	1795,-/73,-
TiN-B	19133	1895,-/77,-



Trinity

povrch	EAN	Kč/EUR
Cr	12943	1185,-/48,-
SNi-br.	12950	1145,-/47,-
TiN-C	12967	1395,-/57,-
TiN-K	12974	1495,-/61,-



Tukan

povrch	EAN	Kč/EUR
SNi-br.	19140	1495,-/61,-
TiN-C	19157	1795,-/73,-
TiN-B	19164	1895,-/77,-



Kliky-rukojeti jsou kalkulovány se zvýhodněnou 50% slevou oproti klikám s rozetou. Uvedená cena je za pár klik-rukojetí. Foto klik s rozetou slouží pouze pro ilustraci.

Kliky-rukojeti k zámkům na sklo

Mini-V

povrch	EAN	Kč/EUR
SNi	19171	695,-/28,-
Cr	19188	745,-/30,-
TiN-K	19195	895,-/37,-



Cesan

povrch	EAN	Kč/EUR
nerez	15982	332,-/14,-
TiN-K	90477	497,-/20,-



Mini-C

povrch	EAN	Kč/EUR
SNi	19201	545,-/22,-
Cr	19218	595,-/24,-
TiN-K	19225	745,-/30,-



Entero

povrch	EAN	Kč/EUR
nerez	15999	417,-/17,-
TiN-K	16255	645,-/26,-



Mini-T

povrch	EAN	Kč/EUR
SNi	19232	645,-/26,-
Cr	19249	695,-/28,-
TiN-K	19256	845,-/34,-



Morgan

povrch	EAN	Kč/EUR
nerez	12754	356,-/15,-
TiN-K	90453	532,-/22,-



Mini-S

povrch	EAN	Kč/EUR
SNi	19263	595,-/24,-
Cr	19270	645,-/26,-
TiN-K	19287	795,-/32,-



Lusy

povrch	EAN	Kč/EUR
nerez	11366	241,-/10,-
TiN-K	90484	482,-/20,-



Kliky nerez

Meclis

povrch	EAN	Kč/EUR
nerez	11465	430,-/18,-
TiN-K	90460	655,-/27,-



Deny

povrch	EAN	Kč/EUR
nerez	11465	430,-/18,-
TiN-K	90460	655,-/27,-



Entero II

povrch	EAN	Kč/EUR
nerez	15999	417,-/17,-
TiN-K	16255	645,-/26,-



Maximální variabilita klik a povrchů



Cr lesklý chrom



TiN-C titan chrom mat



SNi matný nikl



TiN-B titan braun mat



SNi-broušeno matný nikl broušený



TiN-K titan černý mat

Jakákoliv klika z produkce M&T může být kombinována s jakýmkoliv typem zámku na sklo, v jednom z vybraných povrchů. Tímto dokonale sladíte Váš interiér zároveň s kovááním na dřevěných dveřích a dalším doplňkovým kovááním.

ENTERO pant



SNi matný nikel



SNi-broušeno



Cr lesklý chrom



TiN-C titan chrom mat



TiN-K titan černý mat



TiN-B titan braun mat



pant ENTERO	pár pantů	
	Kč/EUR	EAN
SNi matný nikel	2960,-/121,-	88184
SNi-broušeno	2960,-/121,-	90439
Cr lesklý chrom	3570,-/146,-	88160
TiN-C titan chrom mat	3960,-/162,-	88207
TiN-K titan černý mat	4160,-/170,-	88191
TiN-B titan braun mat	4360,-/178,-	88214

Vložka závěsu a střední díl pantu jsou součástí komponentů pantu a jsou zahrnuty v ceně pantu.

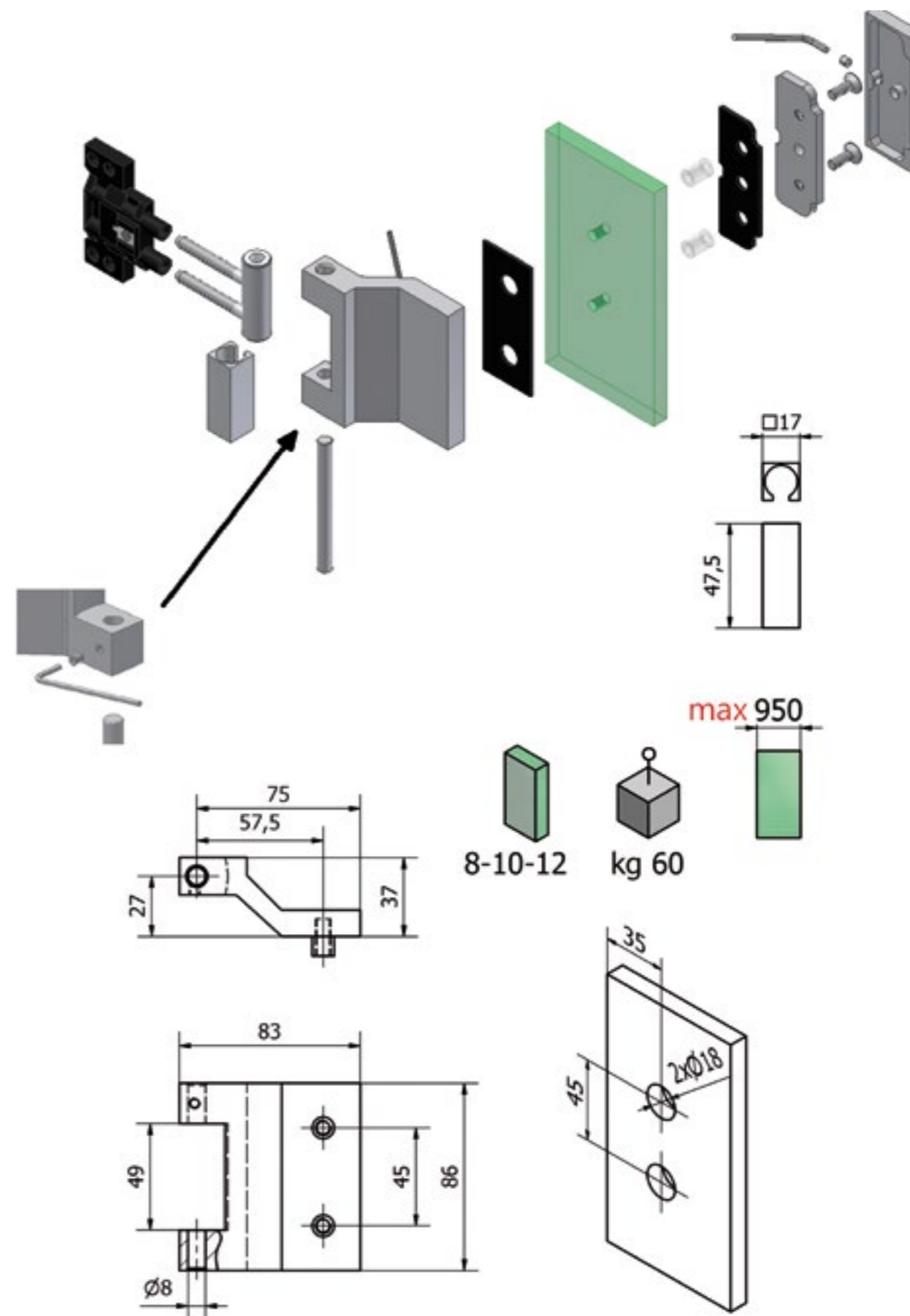

TRINITY pant



TRINITY

MONTÁŽNÍ NÁVOD PANT TRINITY

SNi matný nikl



SNi-broušeno



Cr lesklý chrom



TiN-C titan chrom mat



TiN-K titan černý mat



TiN-B titan braun mat

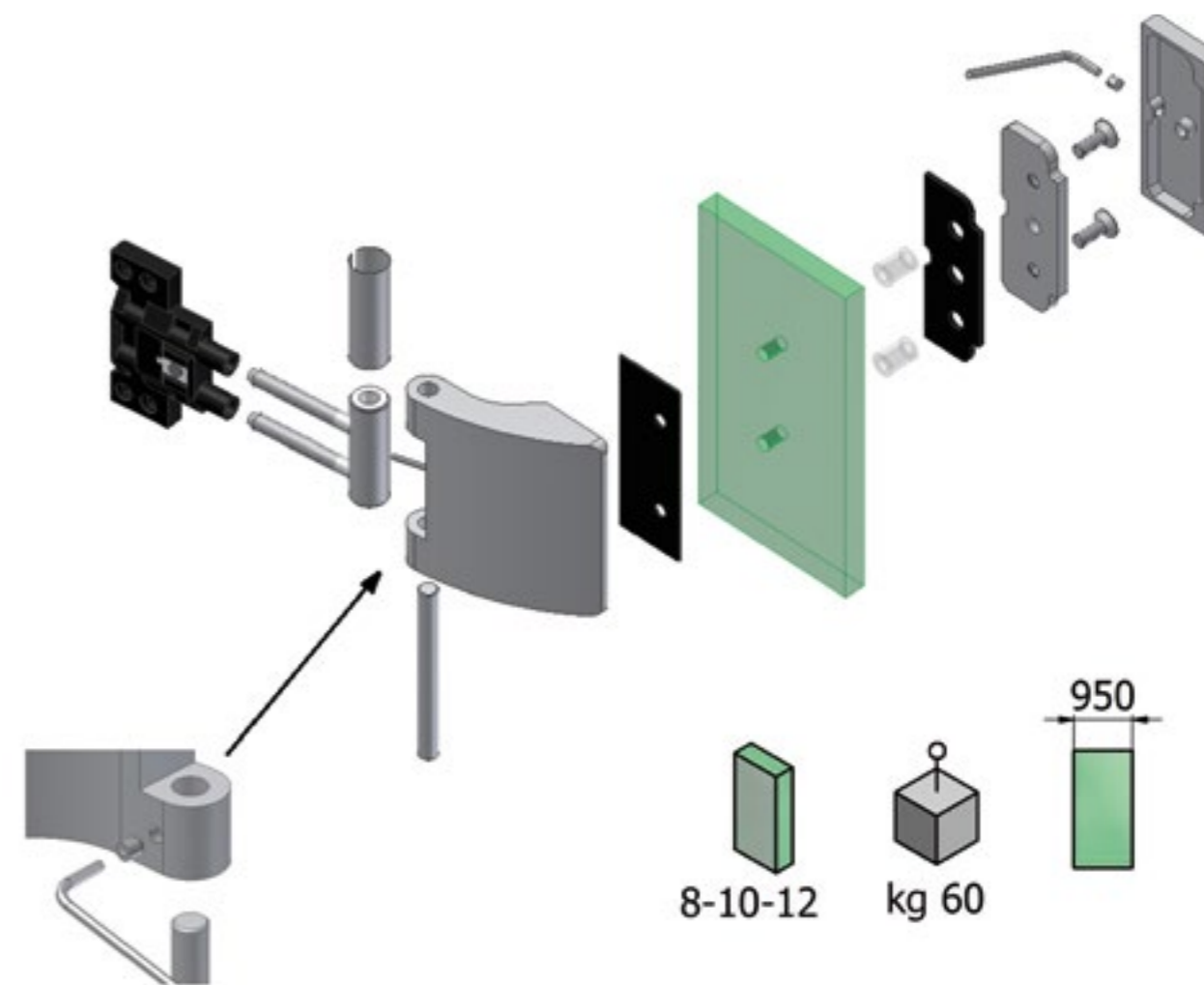

8-10-12

kg 60

950

(1 : 2)

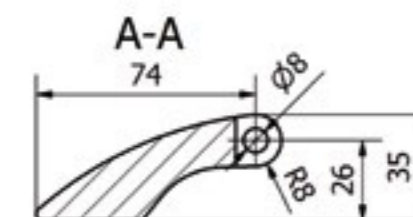
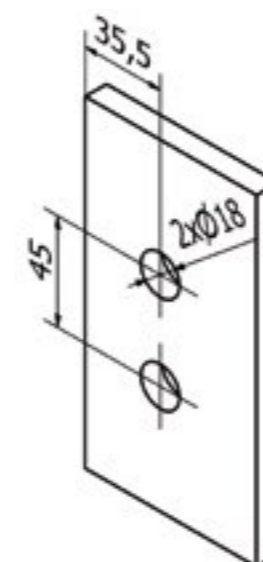
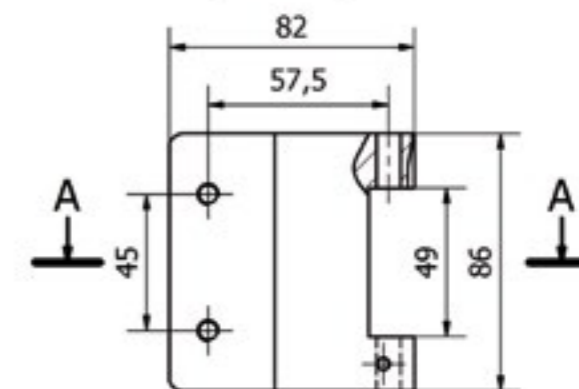

pant TRINITY	pár pantů	
	Kč/EUR	EAN
SNi matný nikl	3588,-/146,-	88122
SNi-broušeno	3588,-/140,-	90422
Cr lesklý chrom	4202,-/172,-	88108
TiN-C titan chrom mat	4520,-/184,-	88146
TiN-K titan černý mat	4720,-/193,-	88139
TiN-B titan braun mat	4920,-/201,-	88153

Vložka závěsu a střední díl pantu jsou součástí komponentů pantu a jsou zahrnuty v ceně pantu

ECONOMY NEREZ



ECONOMY NEREZ

Nerez ocel broušeno



klika Entero

TiN-K titan černý mat



klika Entero II

TiN-K titan černý mat



klika Morgan

Nerez ocel broušeno WC



klika Cesan

Nerez ocel broušeno cylindrický



klika Deny

Nerez ocel broušeno WC



klika Lusy

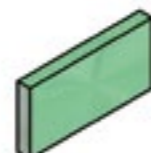
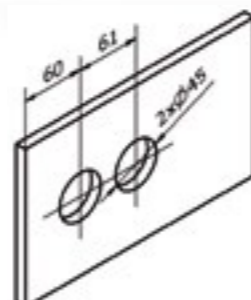
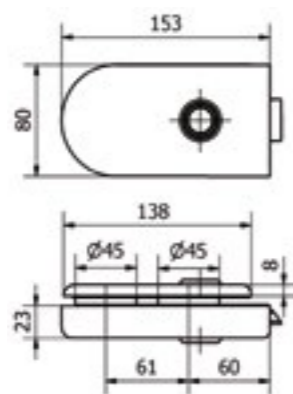
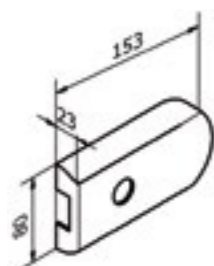

PRO SKLO TL. 8-10-12mm

standard

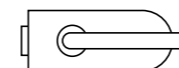

cylindrický



WC

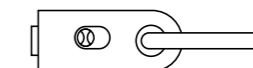

zámek s protikusem



ECONOMY NEREZ

MONTÁŽNÍ NÁVOD ZÁMEK ECONOMY NEREZ

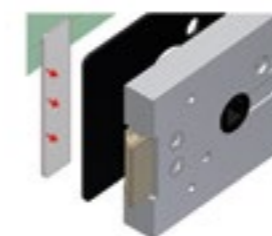
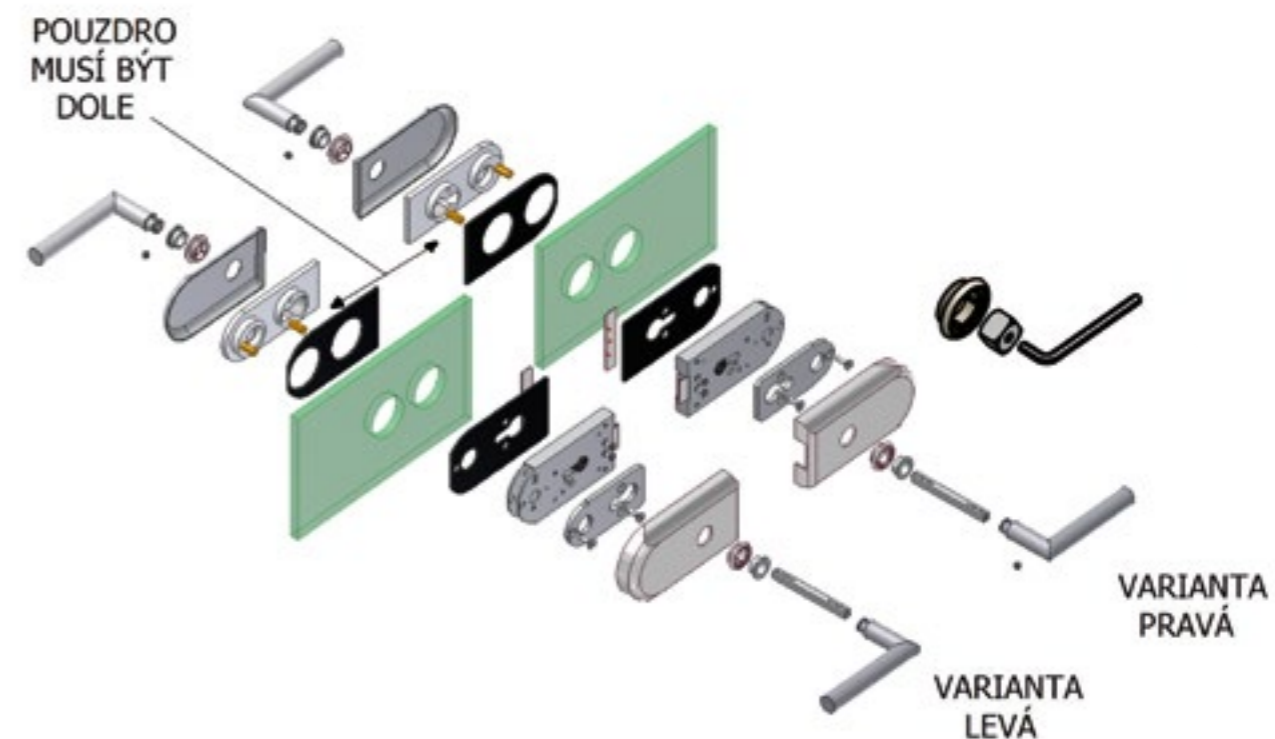

ZÁMEK PRAVO/LEVÝ

LEPENÍ KRYCÍ PÁSKY NA GUMU U STŘELKY ZÁMKU.
Pozn.: TĚSNÍCÍ GUMA PŘESAHUJE OPROTÍ DRUHÉ STRANĚ ZÁMKU

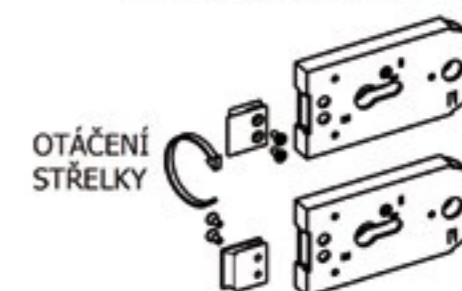

cena za set s panty ECONOMY

zámek ECONOMY	Nerez		TiN-K	
	Kč/EUR	EAN 85950369...	Kč/EUR	EAN 85950369...
standard	4440,-/181,-	88054	5640,-/230,-	90323
cyklindrický	4480,-/183,-	88061	5680,-/232,-	90330
WC	4980,-/203,-	88078	6180,-/252,-	90347
protikus	5180,-/211,-	88085	6380,-/260,-	90446

cena za set s panty ECONOMY OBJEKT

zámek ECONOMY OBJEKT	Nerez		TiN-K	
	Kč/EUR	EAN 85950369...	Kč/EUR	EAN 85950369...
standard	5780,-/236,-	88092	6980,-/285,-	90385
cyklindrický	5820,-/238,-	90354	7020,-/287,-	90392
WC	6320,-/258,-	90361	7520,-/307,-	90408
protikus	6520,-/266,-	90378	7720,-/315,-	90415

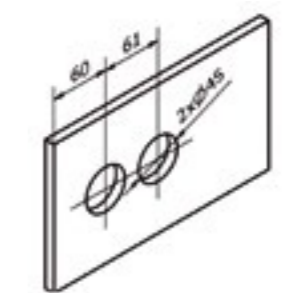
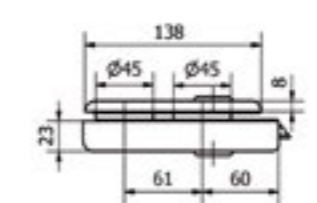
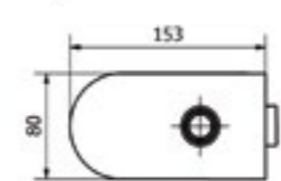
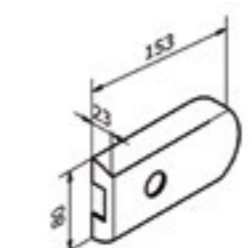

PRO SKLO TL. 8-10-12mm

STEJNÉ ROZMĚRY VRTÁNÍ
PRO ZÁMEK I PROTIKUS

ECONOMY pant



TiN-K titan černý mat



nerez ocel broušeno

MONTÁŽNÍ NÁVOD PANT ECONOMY

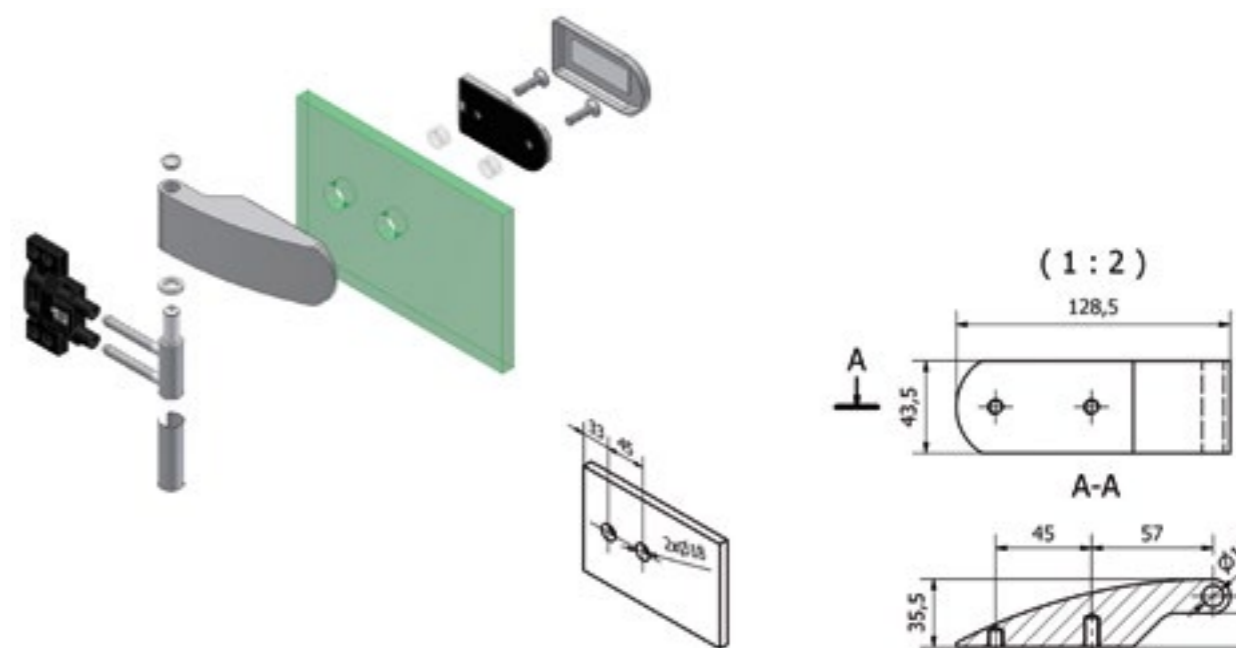

Panty jsou v ceně setu se zámkem Economy.
Spodní díl pantu a vložka závěsu jsou součástí komponentů pantu a jsou také zahrnuty v ceně setu.

ECONOMY OBJEKT pant



TiN-K titan černý mat



nerez ocel broušeno

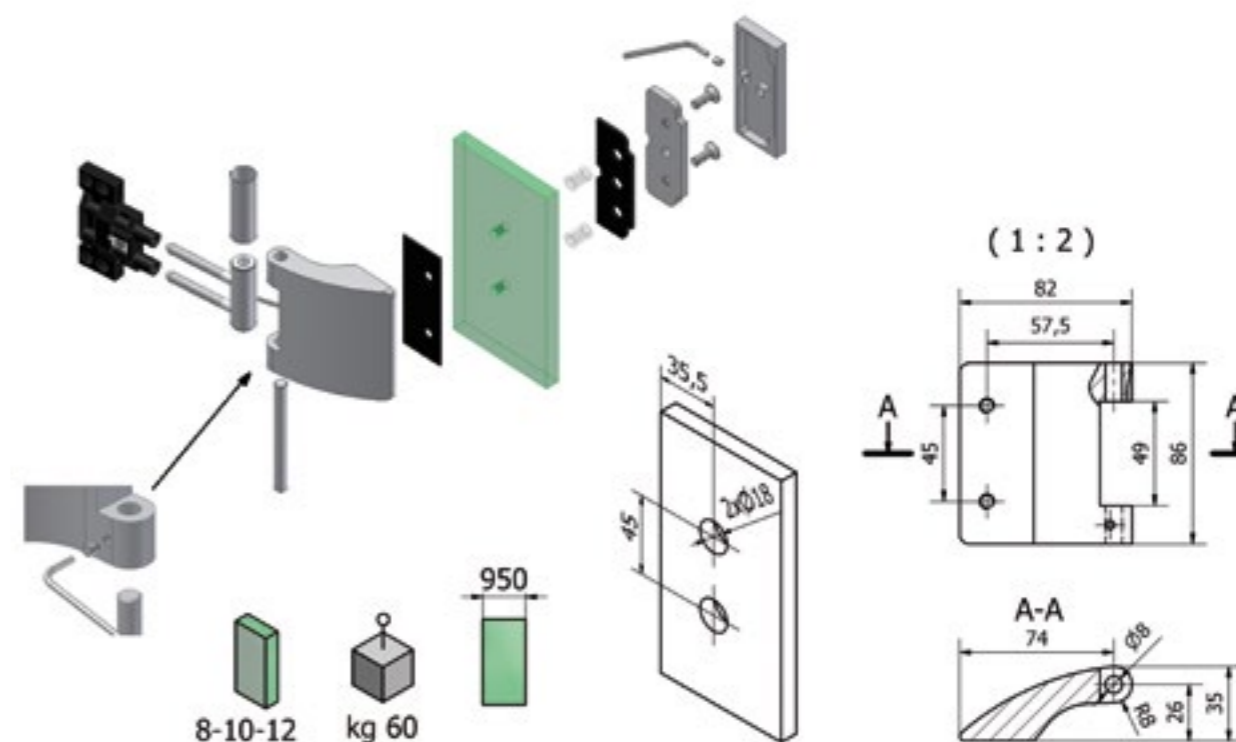

Panty jsou v ceně setu se zámkem Economy Objekt.
Střední díl pantu a vložka závěsu jsou součástí komponentů pantu a jsou také zahrnuty v ceně setu.

MINIMAL mušle na sklo

Se systémem tlačných pružin pro minimalistický design produktu.

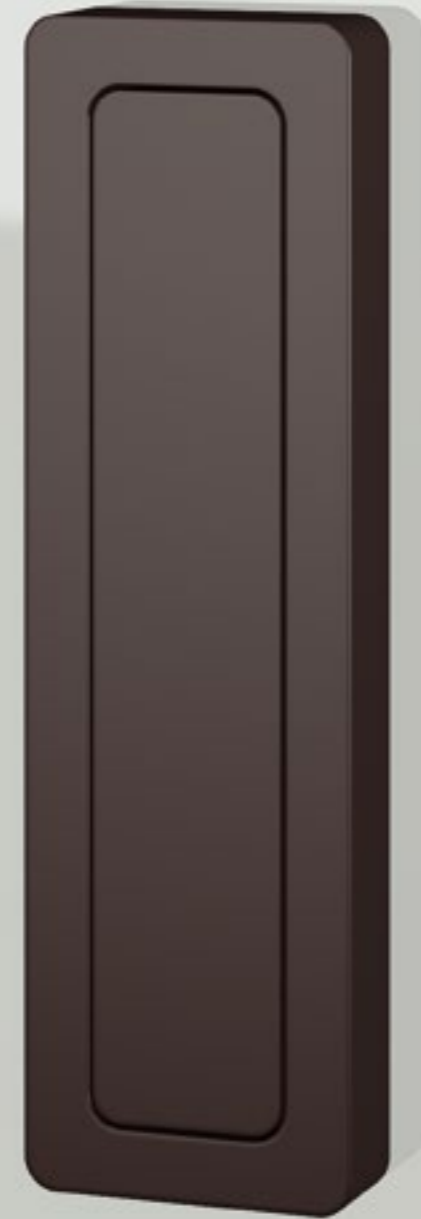

MINIMAL

MONTÁŽNÍ NÁVOD MUŠLE MINIMAL

SNi matný nikel



SNi-broušeno



Cr lesklý chrom



TiN-C titan chrom mat



TiN-K titan černý mat



TiN-B titan braun mat

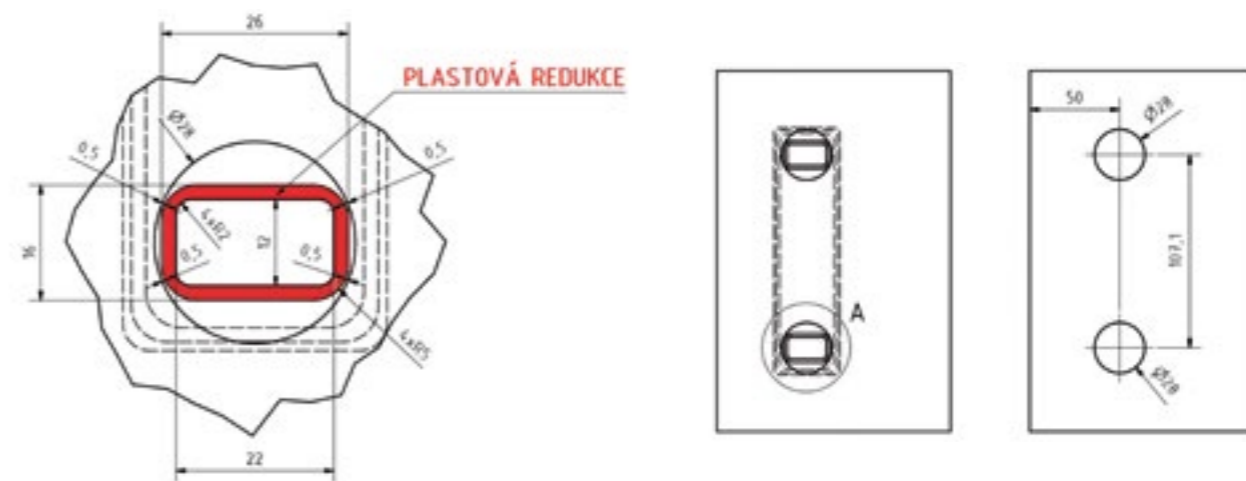
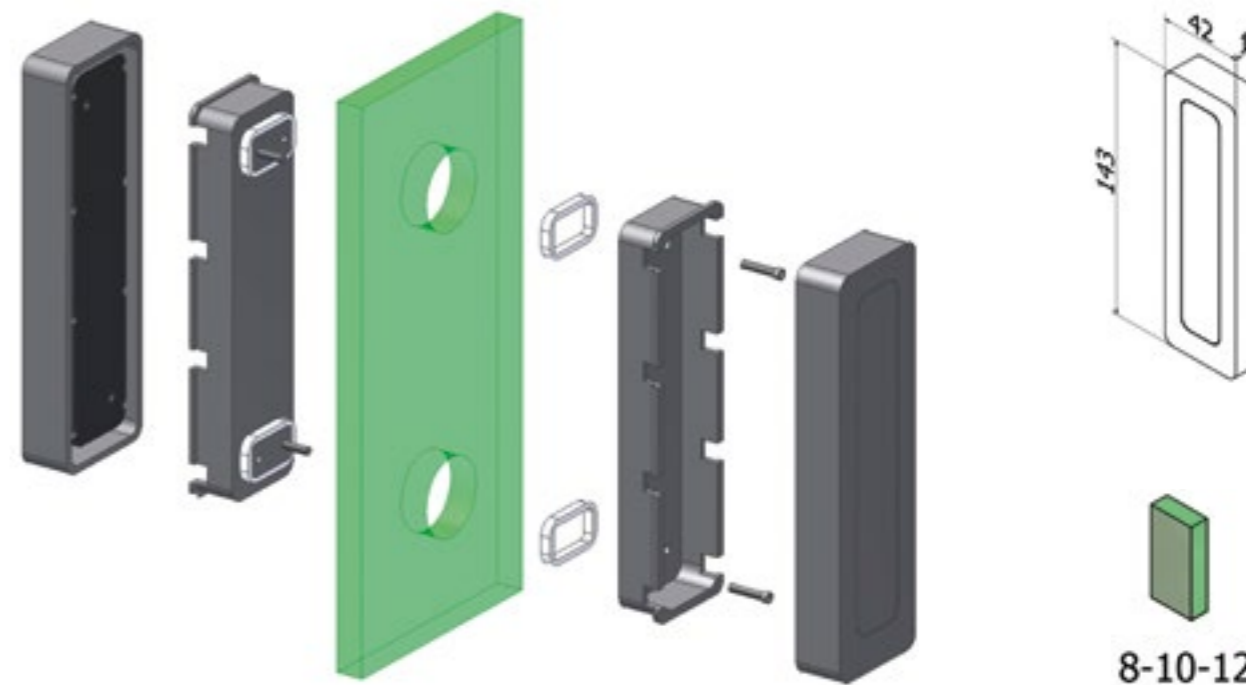

mušle MINIMAL	pár	
	Kč/EUR	EAN
SNi matný nikel	2690,-/110,-	002522
SNi-broušeno	2740,-/112,-	002539
Cr lesklý chrom	2790,-/114,-	002546
TiN-C titan chrom mat	3380,-/138,-	002553
TiN-K titan černý mat	3580,-/146,-	002577
TiN-B titan braun mat	3580,-/146,-	002560



více informací
v kompletním katalogu
Minimal/Maximal

MIMOLIMIT madla



Madla Mimolimit dodáváme v mnoha rozměrech od 300mm až do 2.400mm, v povrchových úpravách matný nikl, matný nikl broušený, lesklý chrom a všech titanových odstínech, s velkým výběrem dřevin - tj. teak, bělený dub, ořech, jilm, dub a dalších podle požadavků zákazníků.

MIMOLIMIT



SNi matný nikel + teak



TiN-B titan braun mat + bělený dub



TiN-K titan černý mat + jilm

MONTÁŽNÍ NÁVOD MADLO MIMOLIMIT

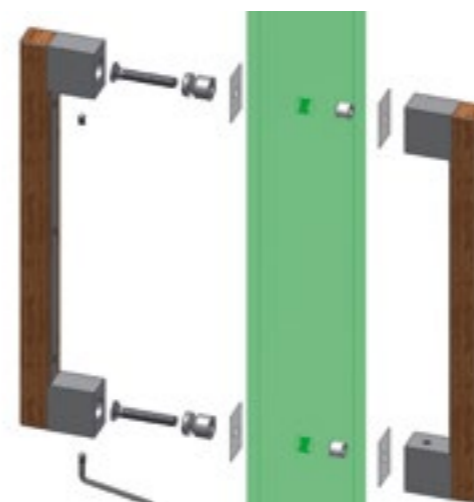
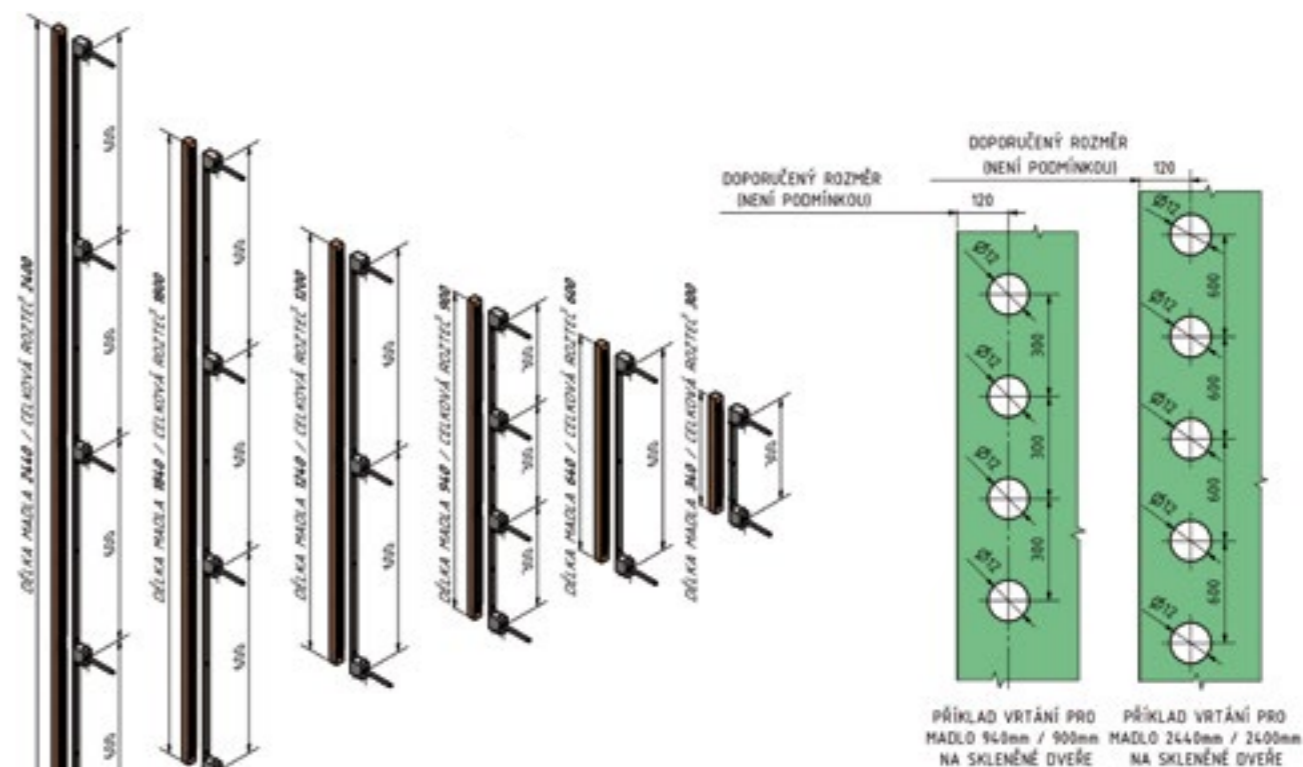

Kompletní přehled variant, povrchových úprav, rozměrů, montáže a cen najdete v hlavním katalogu/ ceníku M&T a na www.kliky-mt.cz

MADLA DODÁVÁME JEDNOSTRANNÁ, NEBO OBOUSTRANNÁ

ENTERO



nerez ocel broušeno

ENTERO II



nerez ocel broušeno

MONTÁŽNÍ NÁVOD MADLO ENTERO, ENTERO II

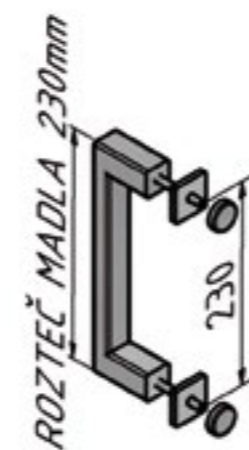
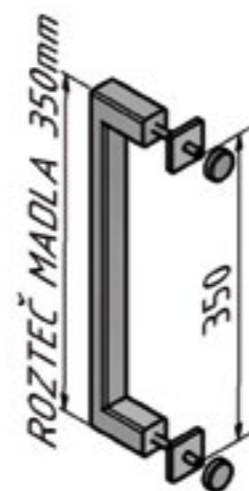

PŘÍKLAD VRTÁNÍ PRO MADLO ROZTEČ 230mm
NA SKLENĚNÉ DVEŘE

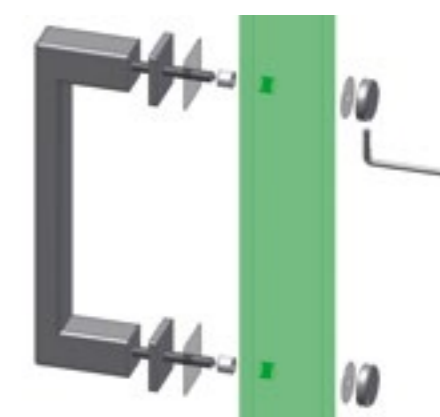
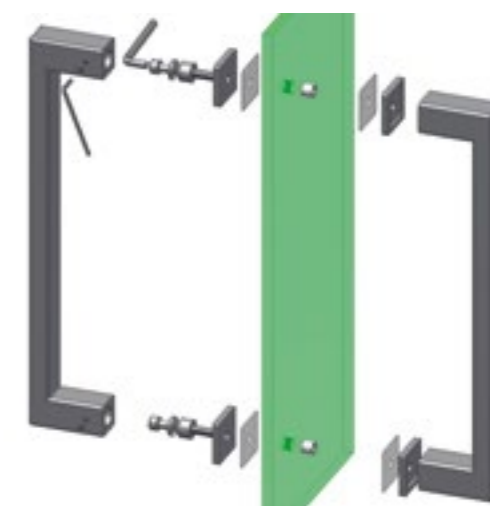
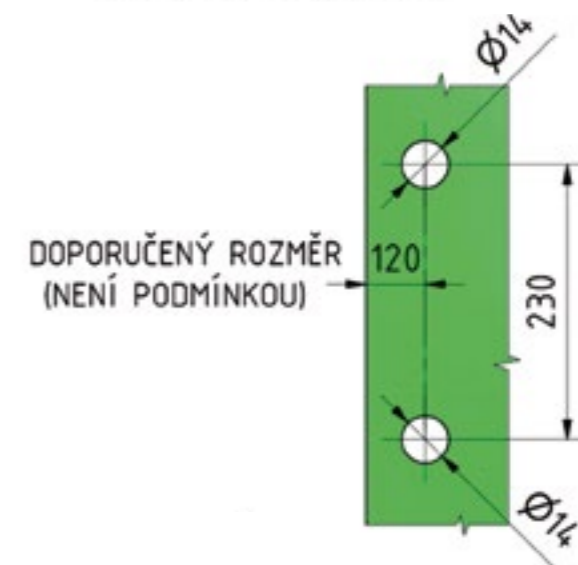

Dodáváme v libovolných rozměrech podle požadavků zákazníka, standardní délky-rozteče jsou 230, 350 a 650mm

Kompletní přehled variant, povrchových úprav, rozměrů, montáže a cen najdete v hlavním katalogu/ ceníku M&T a na www.kliky-mt.cz

MINIMAL

MAXIMAL

MONTÁŽNÍ NÁVOD MADLO MINIMAL, MAXIMAL



Cr lesklý chrom



TiN-B titan braun mat + sklo – bílé glanz



TiN-C chrom mat + 3D ořech



více informací
v kompletním katalogu
Minimal/Maximal

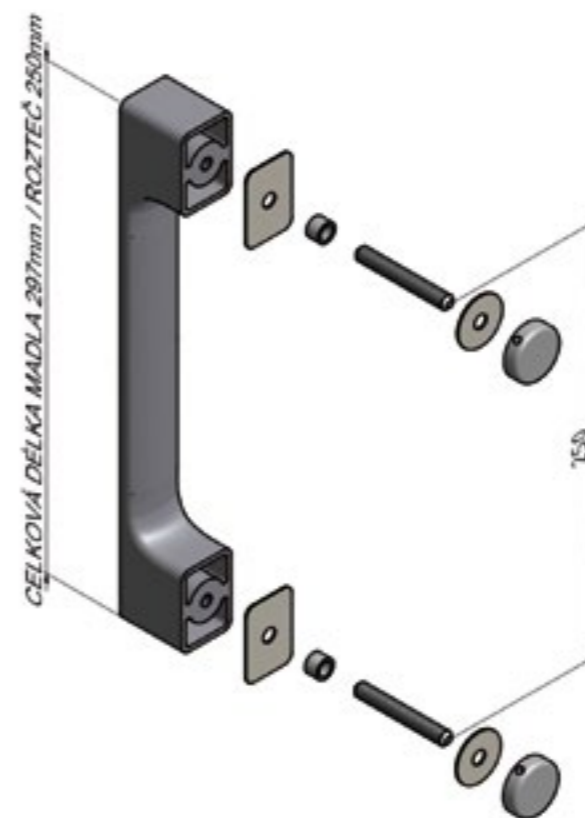

PŘÍKLAD VRTÁNÍ PRO MADLO ROZTEČ 250mm
NA SKLENĚNÉ DVEŘE

DOPORUČENÝ ROZMĚR
(NENÍ PODMÍNKOU)

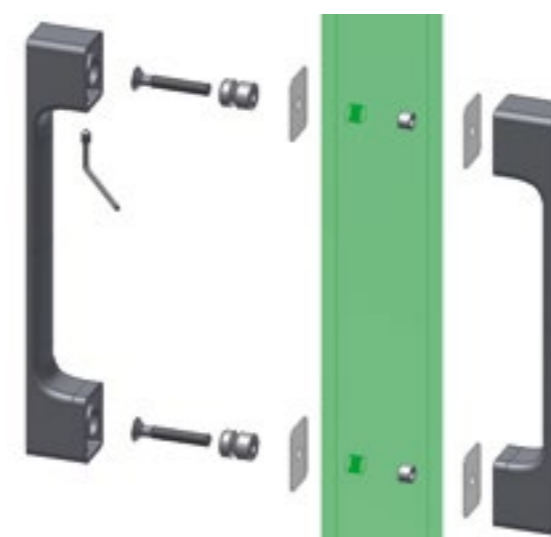
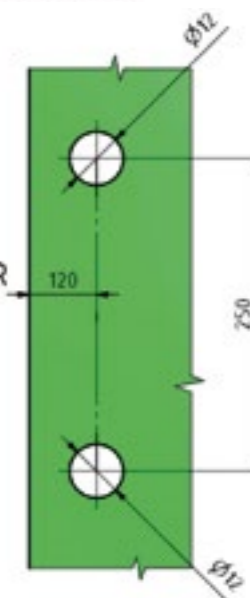

TORO

SNi-broušeno matný nikl broušený



TiN-B titan braun mat



MIMOLIMIT

TiN-K titan černý mat



TiN-B titan braun mat



Dodáváme v mnoha dřevinách a povrchových úpravách

Kompletní přehled variant, povrchových úprav, rozměrů, montáže a cen najdete v hlavním katalogu/ ceníku M&T a na www.kliky-mt.cz

MONTÁŽNÍ NÁVOD MADLO TORO, MIMOLIMIT

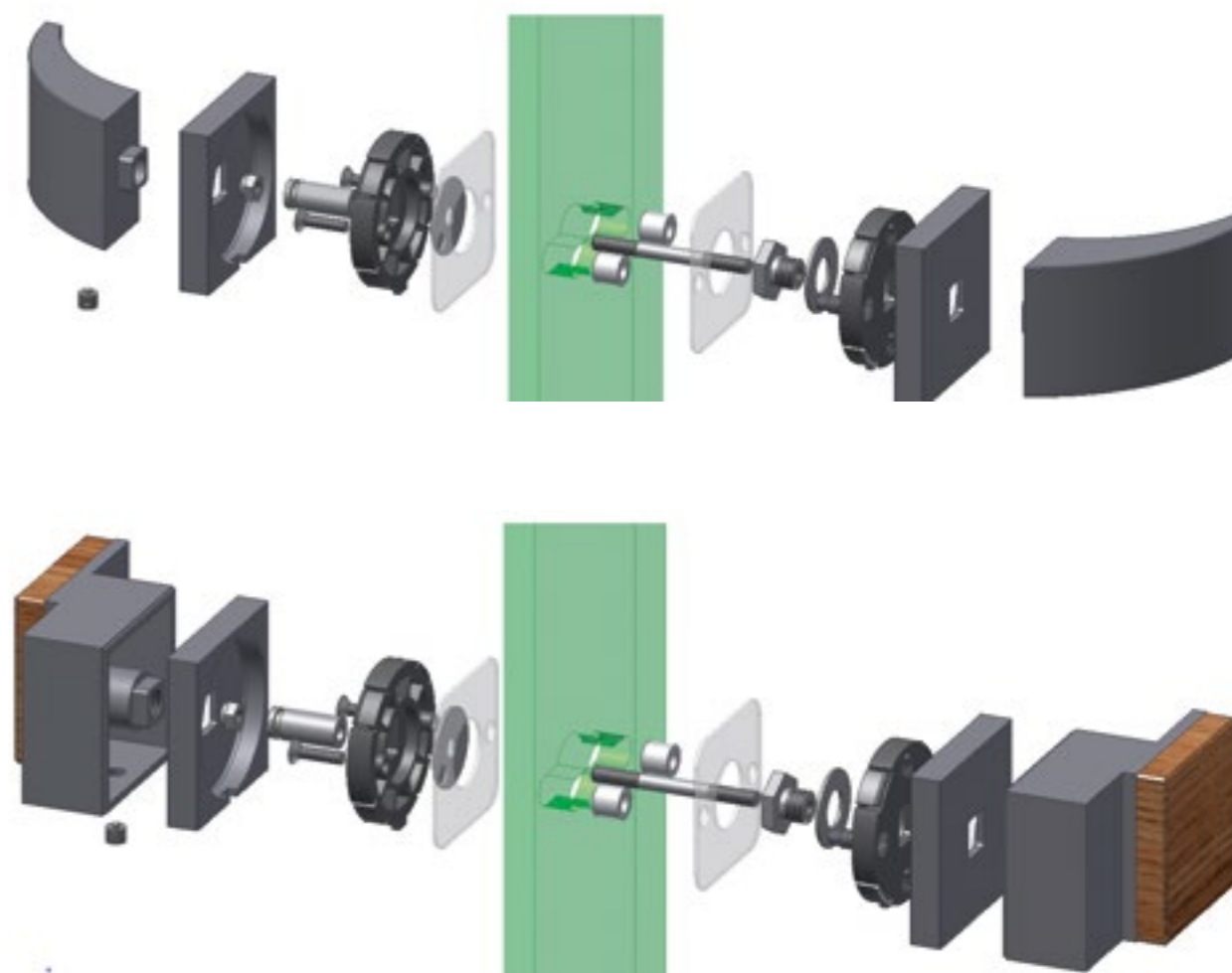

SESTAVA PŘESAZENÉ MADLO NA SKLO

ČERVÍK DO DRÁŽKY UTÁHNOUT
MAXIMÁLNÍ SILOU

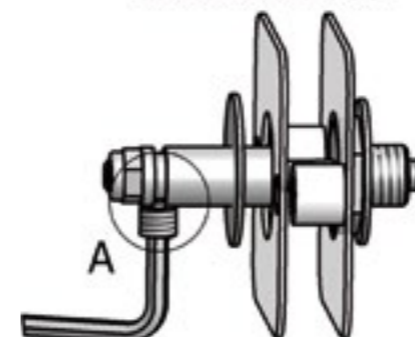

A (2 : 1)

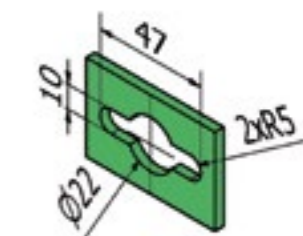

MINIMA GLASS posuvný systém

Inovativní posuvný systém s integrovaným zpomalením a tlumením při dojezdu v obou směrech. Systém Minima se dodává pro skleněné i dřevěné dveře a je připraven ve 4 barevných odstínech. K posuvu doporučujeme systémovou mušli Minimal, dlouhé madlo Minimal, Maximal nebo Mimolimit v barevném provedení jako posuv.



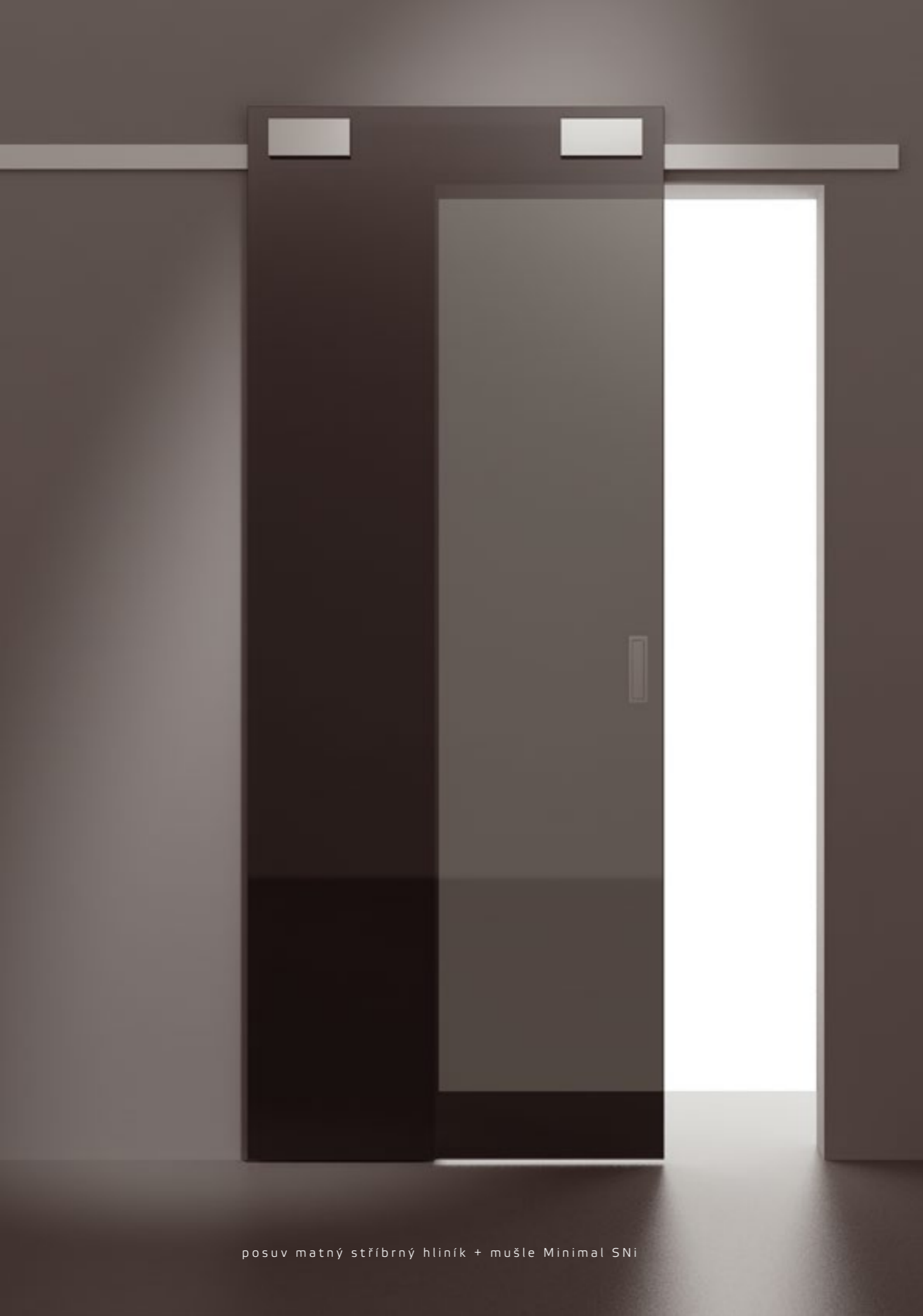

posuv matný stříbrný hliník + mušle Minimal SNI



posuv černý mat + madlo Mimolimit
TiN-K
dřevo teak
délka 1800mm



posuv braun mat + madlo Maximal, výplň korek

System pro skleněné dveře Minima glass

Kompletní set pro dveře se skládá z:

- 1 ks pojezdové lišty
- 1 ks krycí lišty
- 1 sady pojezdů s tlumiči

Celkem celý set je v základním provedení v odstínu matný stříbrný hliník, délka lišty 1700mm, sada s tlumiči pro dveře do hmotnosti 40 kg v ceně od 5.098,- Kč a dále cenově odstupňován podle rozměrů a barevného provedení

Dopravné a balné celého setu účtujeme podle délek lišt:

- do 2000mm .. 90,- Kč + DPH
- do 4000mm .. 300,- Kč + DPH
- do 6000mm .. 500,- Kč + DPH

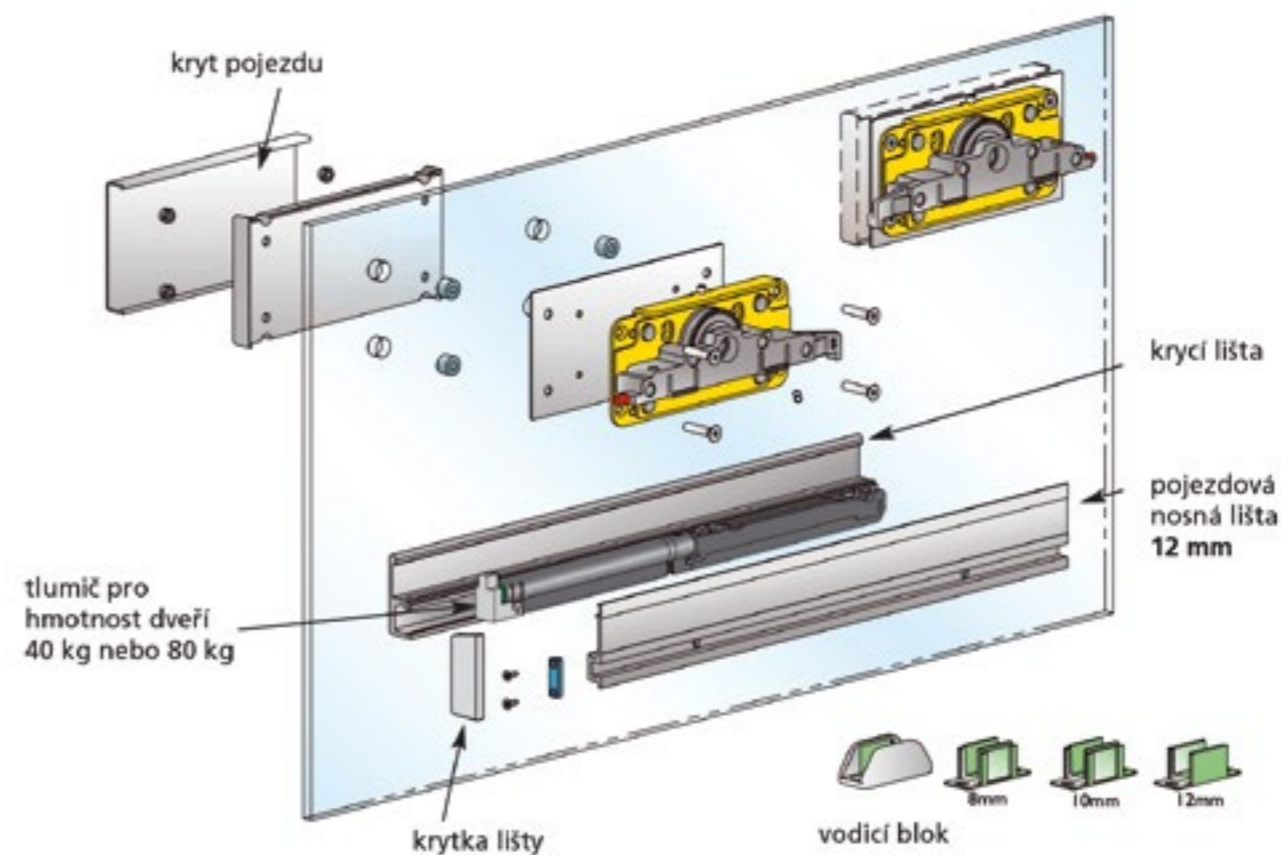

Ceník posuvných systémů Minima glass

		Stříbr. mat. hliník		Leštěná ocel		Černý mat		Braun mat	
		Kč/EUR ks	EAN 85950369...	Kč/EUR ks	EAN 85950369...	Kč/EUR ks	EAN 85950369...	Kč/EUR ks	EAN 85950369...
pojezdová nosná lišta (12mm)	1700mm	723,-/30,-	87057	873,-/36,-	87095	1023,-/42,-	87132	1123,-/46,-	87170
	2000mm	912,-/37,-	87064	1062,-/43,-	87101	1212,-/49,-	87149	1312,-/54,-	87187
	3000mm	1490,-/61,-	87071	1640,-/67,-	87118	1790,-/73,-	87156	1890,-/77,-	87194
	4000mm	2020,-/82,-	87088	2170,-/89,-	87125	2320,-/95,-	87163	2420,-/99,-	87200
	6000mm	2980,-/122,-	89761	3280,-/134,-	89778	3580,-/146,-	89785	3780,-/154,-	89792
krycí lišta	1700mm	985,-/40,-	87378	1235,-/50,-	87415	1485,-/61,-	87453	1685,-/69,-	87491
	2000mm	1154,-/47,-	87385	1404,-/57,-	87422	1654,-/68,-	87460	1854,-/76,-	87507
	3000mm	1942,-/79,-	87392	2192,-/89,-	87439	2442,-/100,-	87477	2642,-/108,-	87514
	4000mm	2585,-/106,-	87408	2835,-/146,-	87446	3085,-/126,-	87484	3285,-/134,-	87521
	6000mm	3890,-/159,-	89846	4380,-/179,-	89853	4880,-/199,-	89860	5280,-/216,-	89877
Minima glass sada s tlumiči 40kg (pro skleněné dveře)		3390,-/138,-	88337	3490,-/142,-	88368	3690,-/151,-	88399	3890,-/159,-	88429
Minima glass sada s tlumiči 80kg (pro skleněné dveře)		3580,-/146,-	88726	3680,-/150,-	88757	3880,-/158,-	88788	4080,-/167,-	88818

- vše ve stejném povrchu**
- kryt pojezdu
 - krytka lišty
 - krycí lišta
 - pojezdová nosná lišta
 - vodící blok

délky lišt
 1700 mm
 2000 mm
 3000 mm
 4000 mm
 individuálně možnost jiného rozměru

- tlumič**
- zelené značení
- pro dveře max. 40 kg
 - žluté značení
- pro dveře max. 80 kg

povrchy - barvy

- hliník matný stříbrný
- braun mat
- černý mat
- leštěná ocel

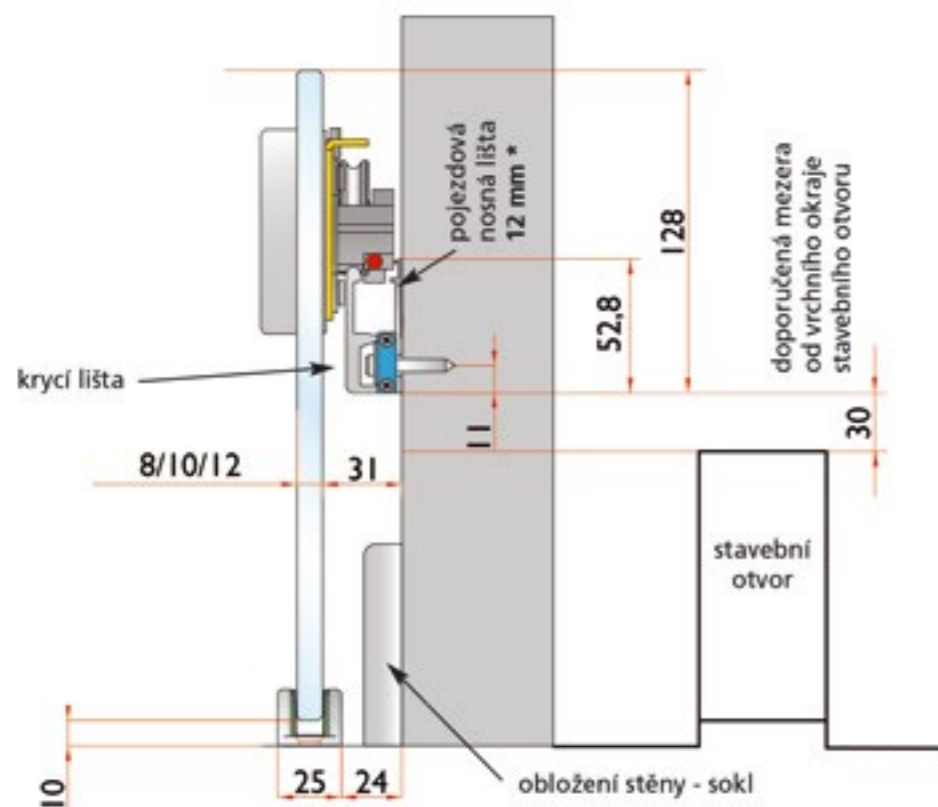

* pro systém Minima glass se používá pojezdová nosná lišta 12 mm

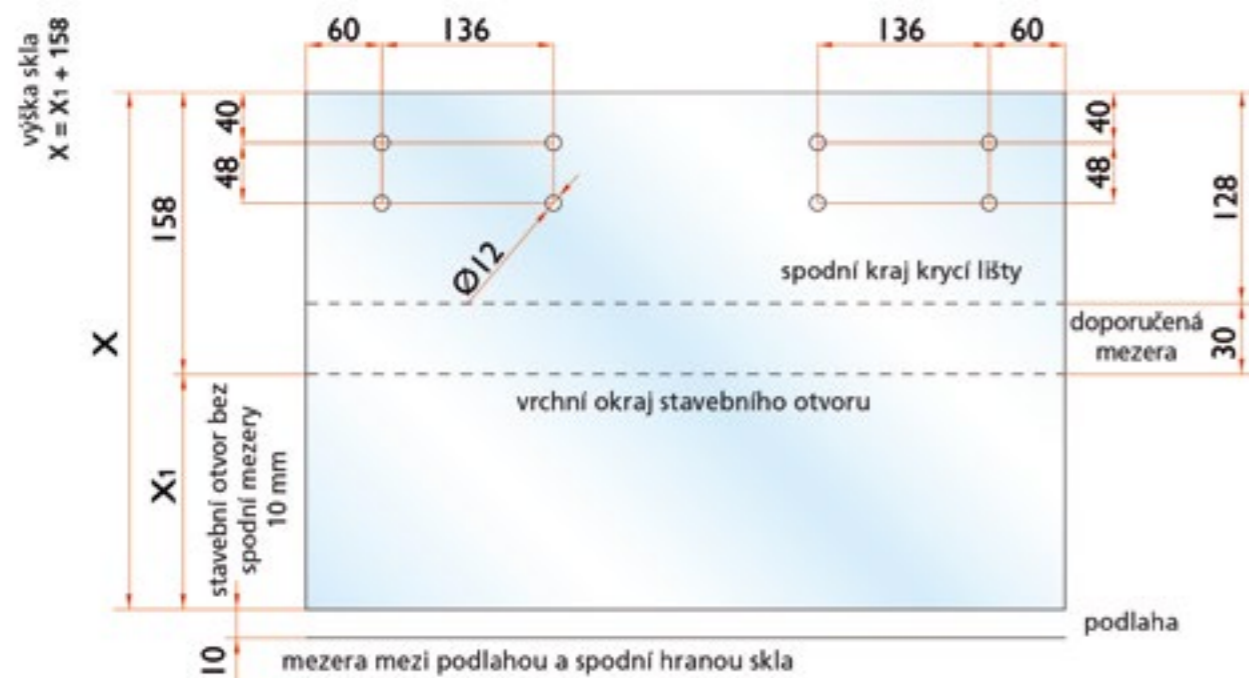

① varianta do volného prostoru - dveře dvoukřídle

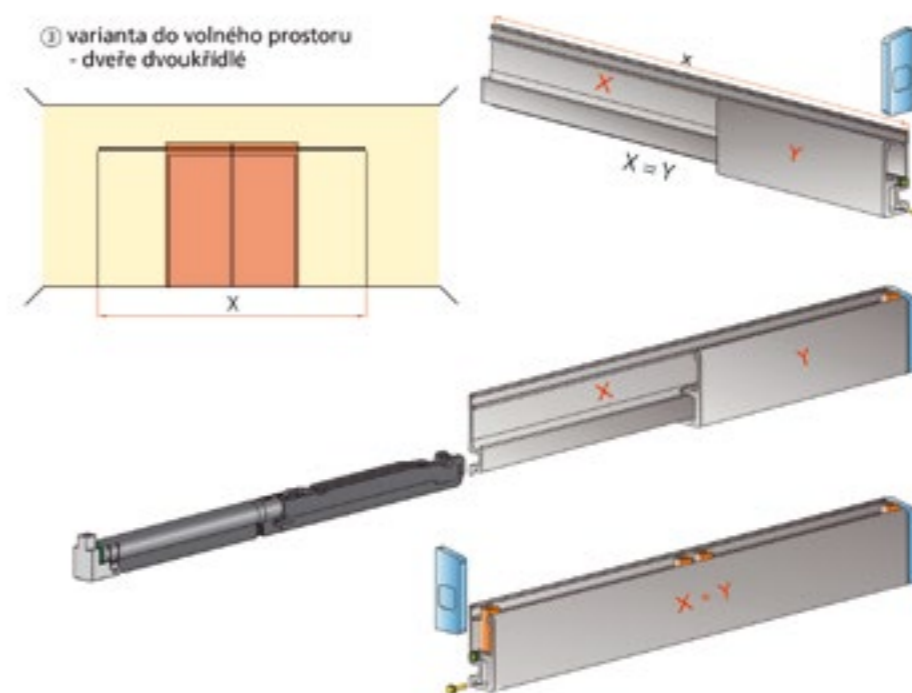

① varianta do volného prostoru - dveře jednokřídle

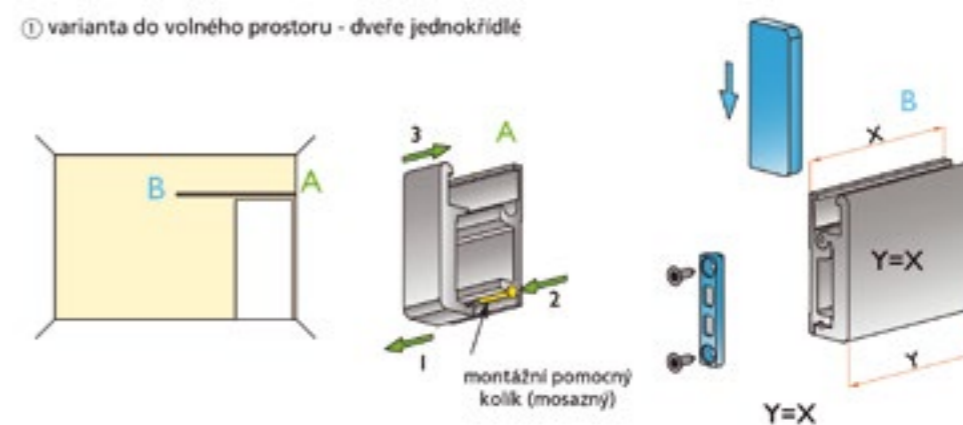

② varianta mezi stěny - dveře dvoukřídle

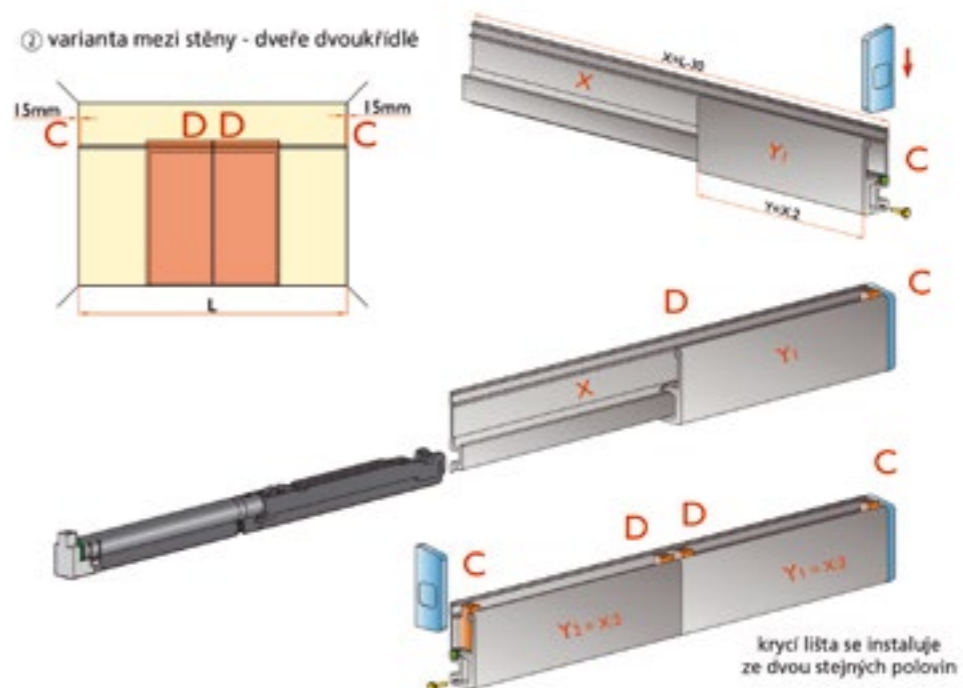

DOPLŇKY

Podložka pro kliku

Povrch	EAN	Kč/EUR	poznámka
černá	88290	12,-/0,50	je součástí a v ceně dodávky zámku v povrchu TiN-C, TiN-K, TiN-B
stříbrná	88306	12,-/0,50	je součástí a v ceně dodávky zámku v povrchu SNI, SNI-broušeno, Cr

Vanička do zárubně krycí

Povrch	EAN	Kč/EUR	poznámka
černá	90897	19,-/0,80	je součástí a v ceně dodávky protiplechu v povrchu TiN-C, TiN-K, TiN-B
stříbrná	90903	19,-/0,80	je součástí a v ceně dodávky protiplechu v povrchu SNI, SNI-broušeno, Cr

Střední díl pantu

EAN	Kč/EUR	poznámka
88221	44,-/1,80	je součástí a v ceně pantu Trinity, Entero, Economy objekt

Vložka závěsu

EAN	Kč/EUR	poznámka
88238	60,-/2,40	Je součástí a v ceně pantu Trinity, Entero, Economy objekt, Economy

Střední díl pantu do kovové zárubně

EAN	Kč/EUR	poznámka
90866	54,-/2,20	není součástí pantu

Spodní díl pantu

EAN	Kč/EUR	poznámka
90873	44,-/1,80	je součástí a v ceně pantu Economy

Spodní díl pantu do kovové zárubně

EAN	Kč/EUR	poznámka
90880	54,-/2,20	není součástí pantu

Západka k dvoukřídlým dveřím pro tl.skla 8-10-12mm, bez vrtání skla

SNI		SNI-broušeno		Cr		TiN-C		TiN-K		TiN-B	
Kč/EUR	EAN	Kč/EUR	EAN	Kč/EUR	EAN	Kč/EUR	EAN	Kč/EUR	EAN	Kč/EUR	EAN
1960,-/80,-	89440	1960,-/80,-	90842	2040,-/83,30	89457	2250,-/91,80	89471	2290,-/93,50	89464	2320,-/94,70	89488

Protiplech do dřevěné zárubně

SNI		SNI-broušeno		Cr		TiN-C		TiN-K		TiN-B	
Kč/EUR	EAN	Kč/EUR	EAN	Kč/EUR	EAN	Kč/EUR	EAN	Kč/EUR	EAN	Kč/EUR	EAN
190,-/7,80	88245	190,-/7,80	90859	240,-/9,80	88252	360,-/14,70	88276	390,-/15,90	88269	420,-/17,10	88283



Vzorkovnice kování na sklo s přehledem designů zámků a barevných variant.
EAN: 008463 CENA: 2900,-

SHOWROOMY, PRODEJNÍ SKLADY

M&T Praha
U Třešňovky 1795/2
tel: +420 286 840 726
+420 776 741 233
e-mail: obchod@kliky-mt-praha.cz
www.kliky-mt-praha.cz

M&T Plzeň
Guldenerova 23
tel: +420 377 243 423
+420 602 414 149
e-mail: objednavky@kliky-mt-plzen.cz
www.kliky-mt-plzen.cz

M&T Bratislava
Tomášikova 10/F
tel: +421 948 939 998
+421 948 682 182
e-mail: info@klucky-mt.sk
www.klucky-mt.sk

M&T Brno
Husovická 21
tel: +420 545 211 213
e-mail: info@kliky-mt-design.cz
www.kliky-mt-brno.cz

M&T Hradec Králové
Collinova 421
tel: +420 495 809 387
e-mail: info@kliky-mt-hk.cz
www.kliky-mt-hk.cz

interiersklo

THE WORLD OF GLASS

- INTERIERSKLO, s.r.o
- Ul. Jesenského 5026/13
(budova poisťovne ALLIANZ a.s.)
- 929 01 Dunajská Stred
- Slovenská republik
- Tel.: +421/031/569 440
- Mobil: +421/918/733 90
- E-mail: info@interiersklo.sk

M&T

Chlístovská 3 | 549 01 Nové Město nad Metují | Česká republika

phone: +420 491 474 632

fax: +420 491 474 625

e-mail: info@kliky-mt.cz

www.kliky-mt.cz

www.doorhandles-mt.com

M&T Slovensko s.r.o. | Tomášikova 10/f, Bratislava | Slovensko

phone: +421 948 939 998

phone: +421 948 682 182

e-mail: info@klucky-mt.sk

www.klucky-mt.sk

graphics design: Michal Hauf

photo: Lumír Smělík, Marek Smělík

© studio IDEAL, 2013, www.ideal-studio.cz